

W1G250-HH37-52 ebmpapst Datasheet FansCo

sales@fansco.com

www.fansco.com

**Nominal data**

<b>Type</b>	<b>W1G250-HH37-52</b>	
<b>Motor</b>	<b>M1G074-BF</b>	
Nominal voltage	VDC	24
Nominal voltage range	VDC	16 .. 28
Type of data definition		fa
Speed	min <sup>-1</sup>	2750
Power input	W	105
Current draw	A	5.0
Max. back pressure	Pa	140
Min. ambient temperature	°C	-25
Max. ambient temperature	°C	60

ml = Max. load · me = Max. efficiency · fa = Running at free air · cs = Customer specs · cu = Customer unit  
Subject to alterations



## Technical features

<b>Mass</b>	2.4 kg
<b>Size</b>	250 mm
<b>Surface of rotor</b>	Coated in black
<b>Material of blades</b>	Sheet steel, coated in black
<b>Material of wall ring</b>	Die-cast aluminium
<b>Number of blades</b>	7
<b>Direction of air flow</b>	"V"
<b>Direction of rotation</b>	Counter-clockwise, seen on rotor
<b>Type of protection</b>	IP 42
<b>Insulation class</b>	"B"
<b>Humidity class</b>	F0
<b>Max. permissible ambient motor temp. (transp./ storage)</b>	+80 °C
<b>Min. permissible ambient motor temp. (transp./storage)</b>	-40 °C
<b>Mounting position</b>	Any
<b>Condensate discharge holes</b>	None
<b>Operation mode</b>	S1
<b>Motor bearing</b>	Ball bearing
<b>Technical features</b>	<ul style="list-style-type: none"> <li>- Control input 0-10 VDC / PWM</li> <li>- Tach output</li> <li>- Motor current limit</li> <li>- Soft start</li> </ul>
<b>EMC interference immunity</b>	Acc. to EN 61000-6-2 (industrial environment)
<b>EMC interference emission</b>	Acc. to EN 55022 (Class B, household environment)
<b>Electrical leads</b>	Via terminal strip
<b>Motor protection</b>	Reverse polarity and locked-rotor protection
<b>Product conforming to standard</b>	EN 60950-1
<b>Approval</b>	CSA C22.2 Nr.77; EAC; UL 1004-1

## Product drawing

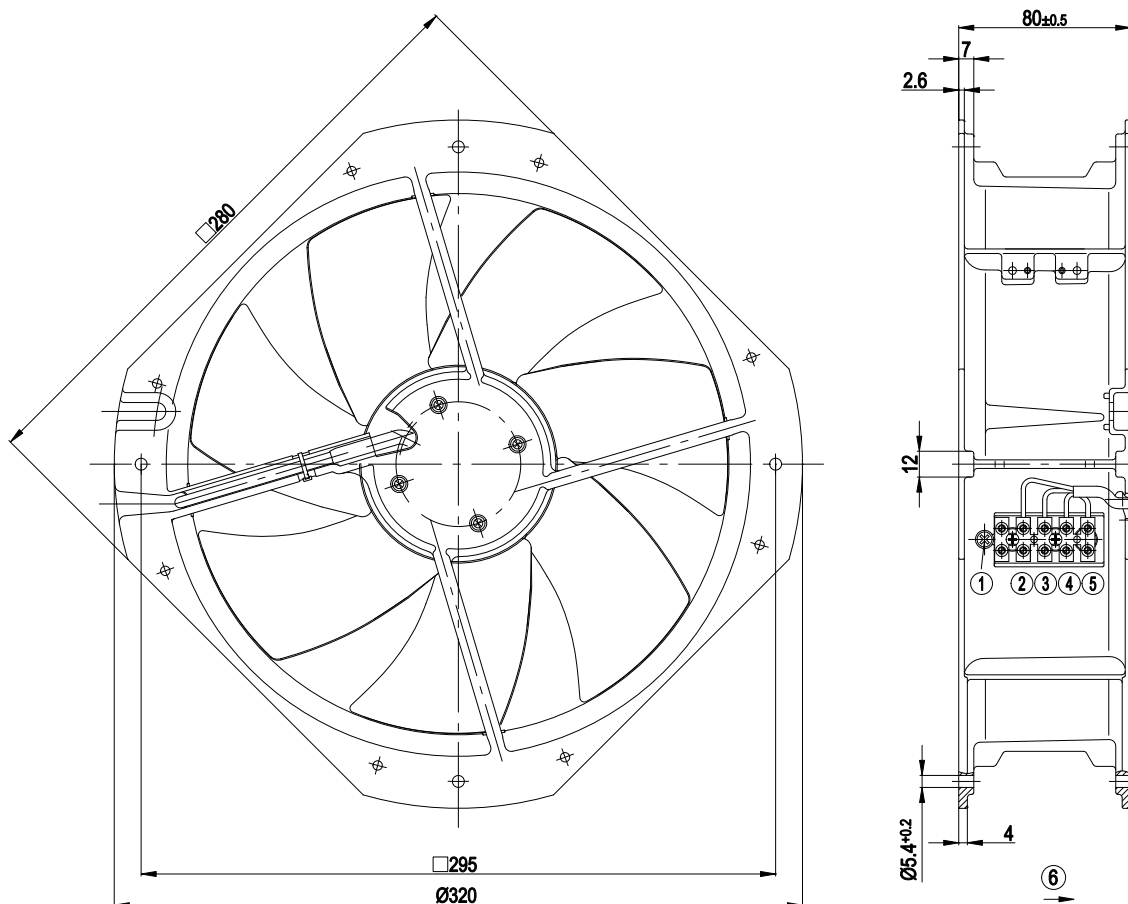

1	Protective earth
2	Yellow control input
3	Speed monitoring, white
4	(-) blue
5	(+) red
6	Direction of air flow "V"

## Connection screen

### Customer circuit

Full speed

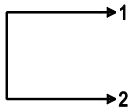

Adjustable speed

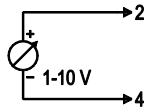

10 V → n = max  
1 V → n = min  
<1 V → n = 0  
Safe start at  
Unom -30%  
from 4 V Ucontr.

Speed adjustable via potentiometer

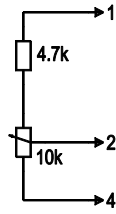

Speed adjustable via PWM 1-10 kHz

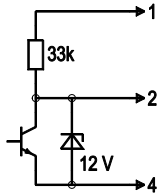

100% PWM → n = max  
10% PWM → n = min  
<10% PWM → n = 0  
Safe start at  
Unom -30%  
from 40% PWM

Preset target value via temperature controller

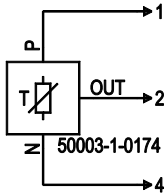

T < 10 °C → n = 0  
T > 45 °C → n = max

### Connection

### Fan/Motor

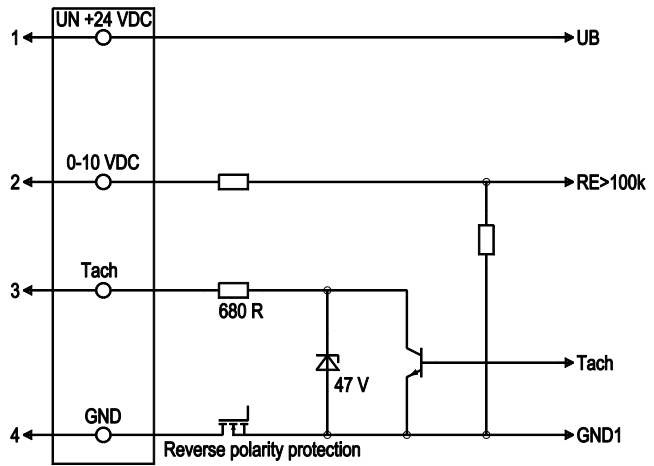

No.	Conn.	Designation	Colour	Function / assignment
1	1	Un +24 VDC	red	Power supply 24 VDC, residual ripple 3.5 %
1	2	0-10 VDC	yellow	Control input Re > 100 K
1	3	Tach	white	Speed monitoring output, 3 pulses per revolution, Isink max = 10 mA
1	4	GND	blue	Reference mass



## Charts: Air flow

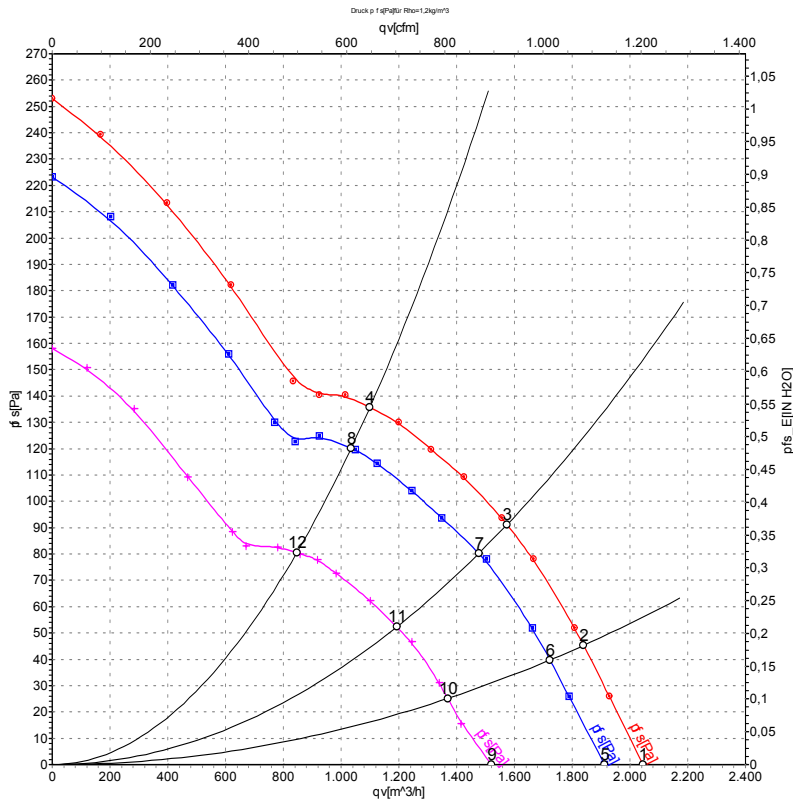

Air performance measured as per ISO 5801 Installation category A. For detailed information on the measuring set-up, please contact ebmpapst. Suction-side noise levels: L<sub>wA</sub> measured as per ISO 13347 / L<sub>pA</sub> measured with 1m distance to fan axis. The values given are valid under the measuring conditions mentioned above and may vary according to the actual installation situation. With any deviation from the standard set-up, the specific values have to be checked and reviewed with the unit installed.

## Measured values

	U	n	P <sub>ed</sub>	I	qv	p <sub>fs</sub>
	V	min <sup>-1</sup>	W	A	m <sup>3</sup> /h	Pa
1	28	2905	125	5.31	2045	0
2	28	2785	128	5.51	1840	46
3	28	2660	131	5.76	1575	91
4	28	2580	134	5.93	1100	136
5	24	2750	105	5.00	1920	0
6	24	2615	106	5.11	1725	40
7	24	2510	108	5.29	1475	80
8	24	2420	110	5.47	1035	120
9	16	2180	53	3.74	1520	0
10	16	2120	56	3.91	1370	25
11	16	2050	59	4.12	1195	52
12	16	1995	61	4.29	845	80

U = Supply voltage · n = Speed · P<sub>ed</sub> = Power input · I = Current draw · qv = Air flow · p<sub>fs</sub> = Pressure increase

