

Product Data Sheet **8315100111**
VCS0045XUGAS
RVE45-3/52/2P

ebmpapst

engineering a better life



RVE45-3/52/2P

INDEX

1 General 3

2 Mechanics 3

2.1 General 3

2.2 Connections 3

3 Operating Data 5

3.1 Electrical Interface - Input 5

3.2 Electrical Operating Data 6

3.3 Electrical Interface - Output 7

3.4 Electrical Features 8

3.5 Aerodynamics 9

3.6 Sound Data 10

4 Environment 10

4.1 General 10

4.2 Climatic Requirements 10

4.3 EMC 10

5 Safety 12

5.1 Electrical Safety 12

5.2 Approval Tests 12

6 Reliability 12

6.1 General 12

1 General

Fan type	Blower	
Rotating direction looking at rotor	Counterclockwise	
Airflow direction	Axial: intake; centrifugal: exhaust	
Bearing system	Ball bearing	
Mounting position - shaft	Any	

2 Mechanics**2.1 General**

Width	64,6 mm	
Height	64,5 mm	
Depth	65,5 mm	
Diameter	57 mm	
Mass	0,16 kg	
Housing material	FDA approved plastics for the air-conducting parts (top and bottom housing) and V0 for the motor and electronics cover	
Impeller material	FDA approved plastics	

2.2 Connections

Electrical connection	Wires	
Lead wire length	L = 365 mm	
Tolerance	+/- 10 mm	
Wire size (AWG)	22	
Insulation diameter	1,7 mm	

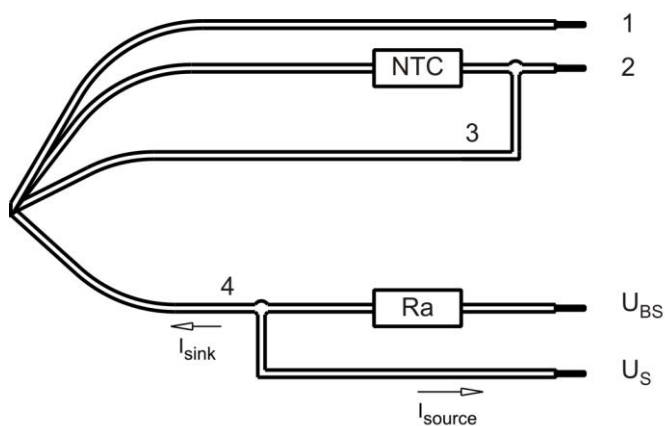

Wire	Color	Operation	Wire size	Insulation diameter
1	red	+ UB	AWG 22	1,7 mm
2	blue	- GND	AWG 22	1,7 mm
3	violet	PWM	AWG 22	1,7 mm
4	white	Tacho	AWG 22	1,7 mm

3 Operating Data

3.1 Electrical Interface - Input

Control input	PWM
---------------	-----

Features

Input type	Open collector	
PWM - Frequency		1 kHz - 10 kHz typical: 2 kHz

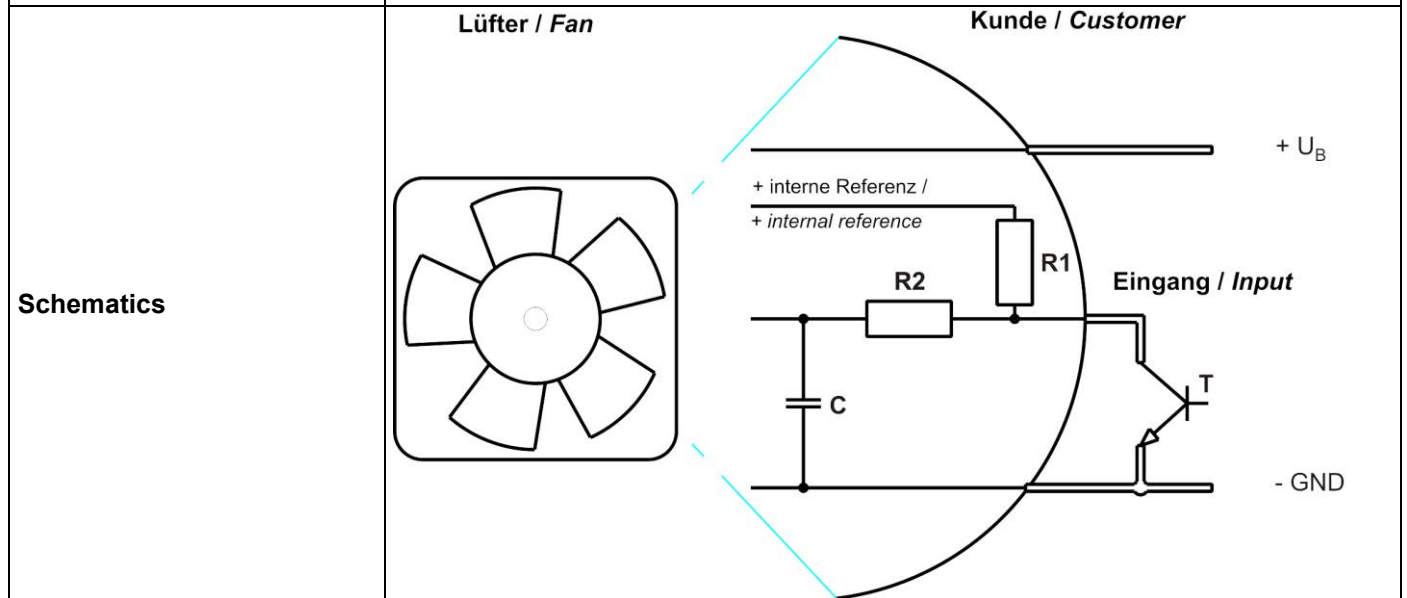
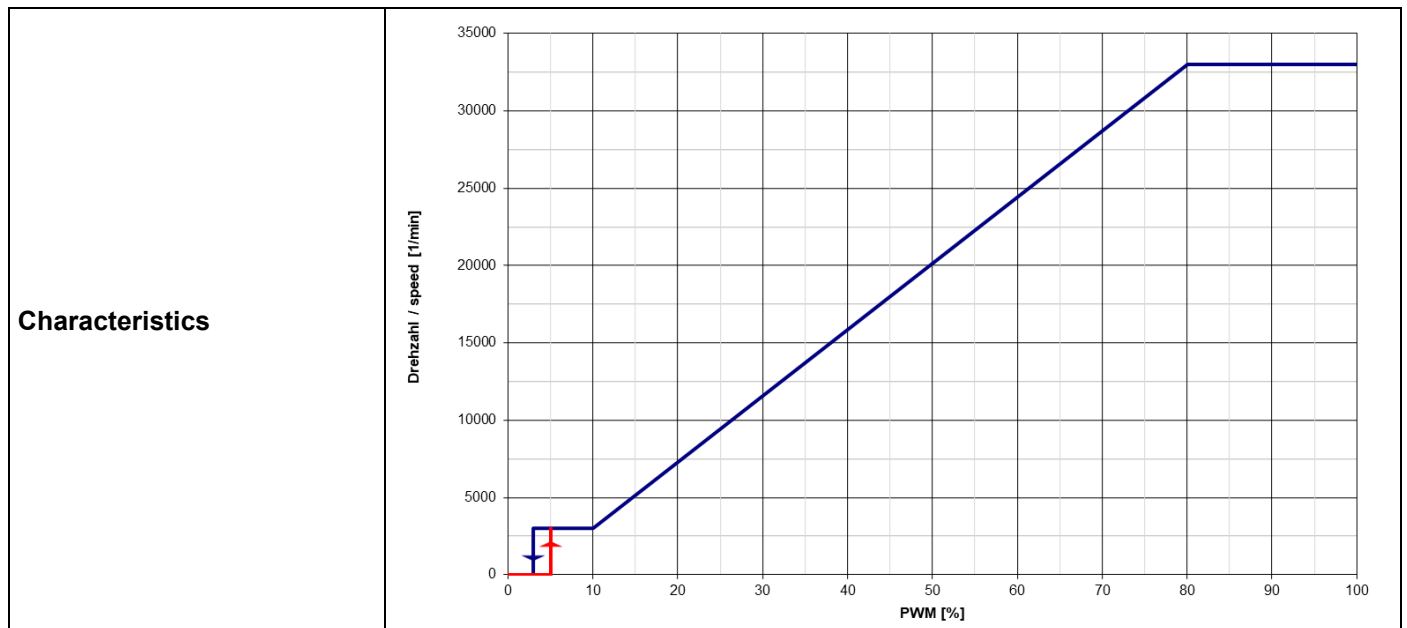

R1=3k3
internal reference voltage: 3,3V

Information to the curve:

- 0 - 5%: 0 1/min (corresponding to minimum speed or power)
- 5 - 10%: 3000 1/min (corresponding to minimum speed)
- 10 - 90%: linearly increasing curve (coming from 0%)
- 90 - 100%: 33.000 1/min (corresponding to maximum speed)
- 100 - 3%: 3000 1/min (corresponding to minimum speed, coming from 100%)
- 3 - 0%: 0 1/min (corresponding to minimum speed or power)

If the setpoint is set to 0%, the fan brakes from < 20,000 rpm.
The fan speed is set (open loop) and not regulated (closed loop). The speed depends on the operating voltage and the operating point. The maximum speed is limited to 40,000 rpm.

3.2 Electrical Operating Data

Measurement conditions: Normal air density = 1,2 kg/m³; Temperature 23°C +/- 3°C; Motor axis horizontal; warm-up time before measuring 5 minutes. In the intake and outlet area should not be any solid obstruction within 0,5 m.

- $\Delta p = 0$: corresp. to free air flow (see chapter aerodynamics)
- l: corresp. to arithm. mean current value

Name	Condition
PWM 0001	PWM: 100 %; f: 2 kHz

Features	Condition	Symbol	Values		
Voltage range		U	9 V		15 V
Nominal voltage		U _N		12 V	
Power consumption	$\Delta p = 0$	P	19 W	29 W	29 W
Tolerance	PWM 0010		+/- 10 %	+/- 5 %	+/- 5 %
Current consumption	$\Delta p = 0$	I	2.100 mA	2.400 mA	1.900 mA
Tolerance	PWM 0010		+/- 10 %	+/- 5 %	+/- 5 %
Speed	$\Delta p = 0$	n	29.000 1/min	33.000 1/min	33.000 1/min
Tolerance	PWM 0010		+/- 10 %	+/- 5 %	+/- 5 %
Starting current consumption				<= 3.000 mA	

3.3 Electrical Interface - Output

Tacho type	/2 (open collector)
------------	---------------------

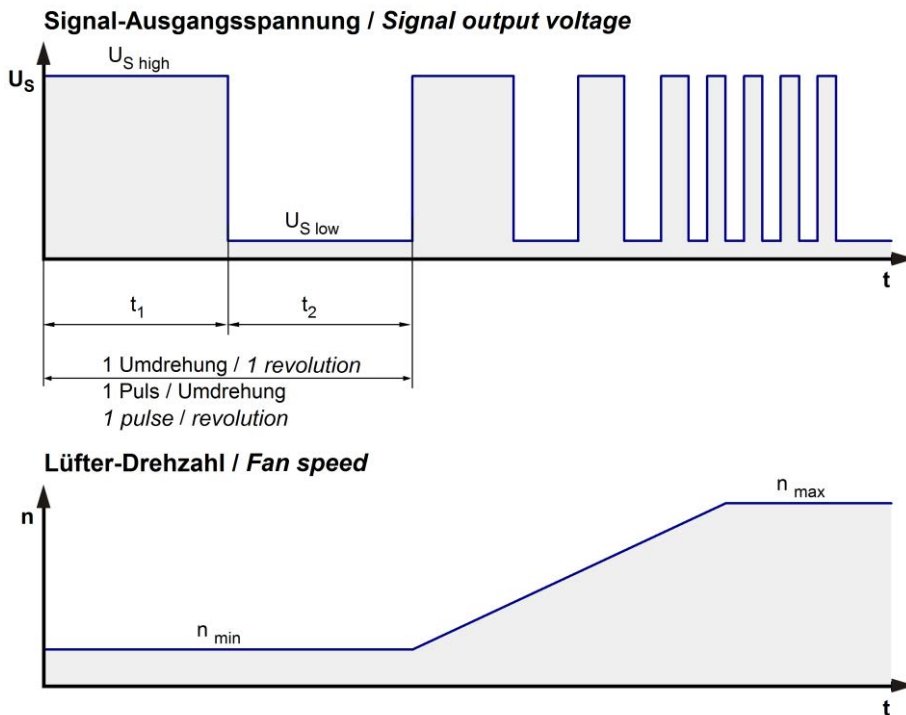

$$R_a = \frac{U_{BS} - U_{S\ low}}{I_{sink}}$$

Lüfter / Fan Kunde / Customer

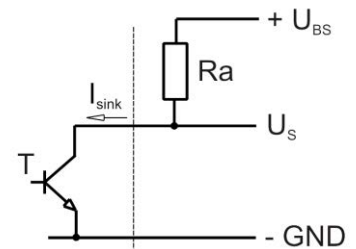

Features	Note	Values
Tacho operating voltage	U_{BS}	$\leq 30\ V$
Tacho signal Low	$U_{S\ low}$	$I_{sink}: 2\ mA$ $\leq 0,4\ V$
Tacho signal High	$U_{S\ high}$	$I_{source}: 0\ mA$ $\leq 30\ V$
Maximum sink current	I_{sink}	$\leq 4\ mA$
Maximum source current		$0\ mA$
External resistor	External resistor R_a from U_{BS} to U_S required. All voltages measured to GND.	
Tacho frequency	$n / 60$	$550\ Hz @ 33.000\ 1/min$
Tacho isolated from motor	No	
Slew rate		$\geq 0,5\ V/\mu s$

n = revolutions per minute (1/min)

3.4 Electrical Features

Electronic function	Open loop speed	
Reversed polarity protection	N-CH FET	
Max. residual current at U_N	$I_F \leq 1 \text{ mA}$	
Locked rotor protection	Auto restart	
Locked rotor current at U_N	I_{block} approx. 70 mA	
Clock signal at locked rotor	t_3 / t_4 typical: 0,22 s / 0,22 s	
Internal fuse	Littelfuse NANO2 > Very Fast-Acting > 451/453 Series 5A / 125V (Art.No.: 0451005.MRL)	
Voltage control *)	Fan turns on at $U_B > 9 \text{ V}$ or $< 16 \text{ V}$ Fan turns off at $U_B < 8 \text{ V}$ or $> 17 \text{ V}$	

*) This fan has an undervoltage and overvoltage control circuit integrated which turns the motor off if the voltage is out of range.

3.5 Aerodynamics

Measurement conditions: Measured with a double chamber intake rig acc. to DIN EN ISO 5801. Normal air density = 1,2 kg/m³; Temperature 23°C +/- 3°C; In the intake and outlet area should not be any solid obstruction within 0,5 m. Motor shaft horizontal.

The information is only valid under the specified test conditions and may be changed by the installation conditions. If there are deviations from the standard test conditions, the characteristic values must be checked under the installed conditions. Power consumption of the fan motor when operating at normal voltage is shown. Depending on the operating conditions of the application, the power input may be higher.

a.) Operation condition:

33.000 1/min at free air flow	PWM 100 %; f: 2 kHz		
-------------------------------	---------------------	--	--

Max. free-air flow ($\Delta p = 0 / \dot{V} = \text{max.}$)	27 m ³ /h	
Max. static pressure ($\Delta p = \text{max.} / \dot{V} = 0$)	4.200 Pa	

The fan must not be operated at < 1m³ / h.

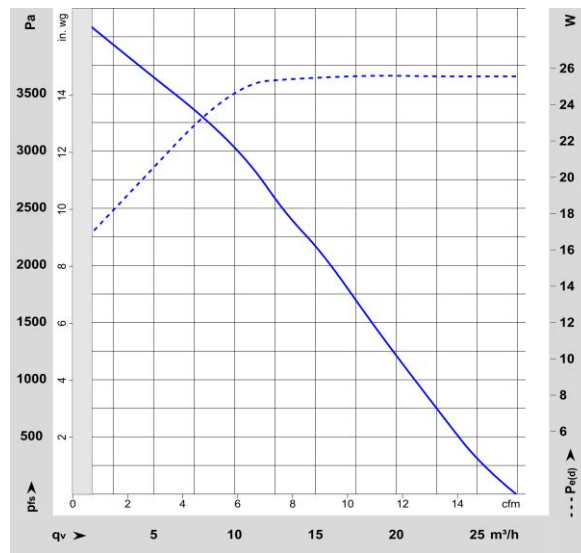

3.6 Sound Data

Measurement conditions: Sound pressure level: 1 meter distance between microphone and the air intake.
Sound power level: According to ISO 10302-1
Measured in a semianechoic chamber with a background noise level of $L_p(A) < 5 \text{ dB(A)}$
For further measurement conditions see chapter aerodynamics.

a.) Operation condition:

33.000 1/min at free air flow	PWM 100 %; f: 2 kHz		
-------------------------------	---------------------	--	--

Optimal operating point	15 m ³ /h @ 2.170 Pa		
Sound power level at the optimal operating point	7,2 bel(A)		
Sound pressure level at free air flow, measured in rubber bands			

4 Environment

4.1 General

Min. permitted ambient temperature TU min.	-20 °C		
Max. permitted ambient temperature TU max.	65 °C		
Min. permitted storage temperature TL min.	-40 °C		
Max. permitted storage temperature TL max.	85 °C		

4.2 Climatic Requirements

Humidity requirements	humid heat, constant; according to DIN EN 60068-2-78, 14 days		
Water exposure	None		
Dust requirements	None		
Salt fog requirements	None		

Permitted application area:

The product is intended for use in sheltered rooms with controlled temperature and controlled humidity. Directly exposure to water must be avoided.

Pollution degree 1 (according DIN EN 60664-1)

There is either no pollution or it occurs only dry, non-conductive pollution. The pollution has no negative impact.

Please require severity levels and specification parameters from the responsible development departments.

4.3 EMC

Kind	Electrostatic Discharge Immunity Test
According	DIN EN 61000-4-2:2001-12
Ceck accuracy / Limit	Contact Discharge +/- 4 kV; Air Discharge +/- 8 kV
Result	A: The monitored function operates as designed during and after exposure to a disturbance.

Kind	Electromagnetic Field Immunity Test
According	DIN EN 61000-4-3:2006-12
Check accuracy / Limit	10 V/m; 80 - 1000 MHz; AM; m = 0,8; f = 1 kHz; 1%; t = 3 s
Result	A: The monitored function operates as designed during and after exposure to a disturbance.

Kind	Electrical Fast Transient / Burst Immunity Test
According	DIN EN 61000-4-4:2005-07
Check accuracy / Limit	+/- 2 kV on Power Lines; Coupling: POS, NEG, {PE}, ALL, 5 kHz and 100 kHz; 1 min
Result	A: The monitored function operates as designed during and after exposure to a disturbance.

Kind	Immunity to Conducted Disturbances, Induced by RF-Fields
According	DIN EN 61000-4-6:2001-12
Check accuracy / Limit	10 Vrms; 150 kHz - 80 MHz; AM; m = 0,8; f = 1 kHz; 1%; t = 3 s
Result	A: The monitored function operates as designed during and after exposure to a disturbance.

5 Safety**5.1 Electrical Safety**

Dielectric strength DIN EN 62368 and DIN EN 60335 A.) Type test Measuring conditions: After 48h of storage at 95% R.H. and 25°C. No arcing or breakdown is allowed! All connections together to ground.	500 VAC / 1 Min.	
B.) Routine test Measuring conditions: At indoor climate. No arcing or breakdown is allowed! All connections together to ground.	850 VDC / 1 Sec.	
Isolation resistance Measuring conditions: After 48h of storage at 95% R.H. and 25°C measured with U=500 VDC for 1 min.	RI > 10 MOhm	
Clearance / creepage distance	1,0 mm / 1,2 mm	
Protection class	III	

5.2 Approval Tests

CE	EC Declaration of Conformity	Yes
EAC	Eurasian Conformity	Yes
UL	Underwriters Laboratories	Yes / UL507, Electric Fans E38324
VDE	Association for Electrical, Electronic and Information Technologies	Yes / Approval acc. to EN 62368 - Audio/video, information and communication technology equipment
CSA	Canadian Standards Association	Yes / CSA audited by UL according to C22.2 No. 113 Fans and Ventilators
CCC	China Compulsory Certification	Not applicable

6 Reliability**6.1 General**

Life expectancy L10 at TU = 40 °C	17.500 h	
Life expectancy L10 at TU max.	8.500 h	
Life expectancy L10 acc. to IPC 9591 at TU = 40 °C	27.500 h	
Life expectancy L10 acc. to IPC 9591 at TU = 25 °C	45.000 h	

The reproduction, distribution and utilization of this document as well as the communication of its contents to others without express authorization is prohibited. Offenders will be held liable for the payment of damages. All rights reserved in the event of the grant of a patent, utility model or design. Refer to protection notice ISO 16016! Note: in case of multilingual information in this document and in the applicable documents referred to in this document, only the English version shall be authoritative and legally binding in the event of contradictions in content.

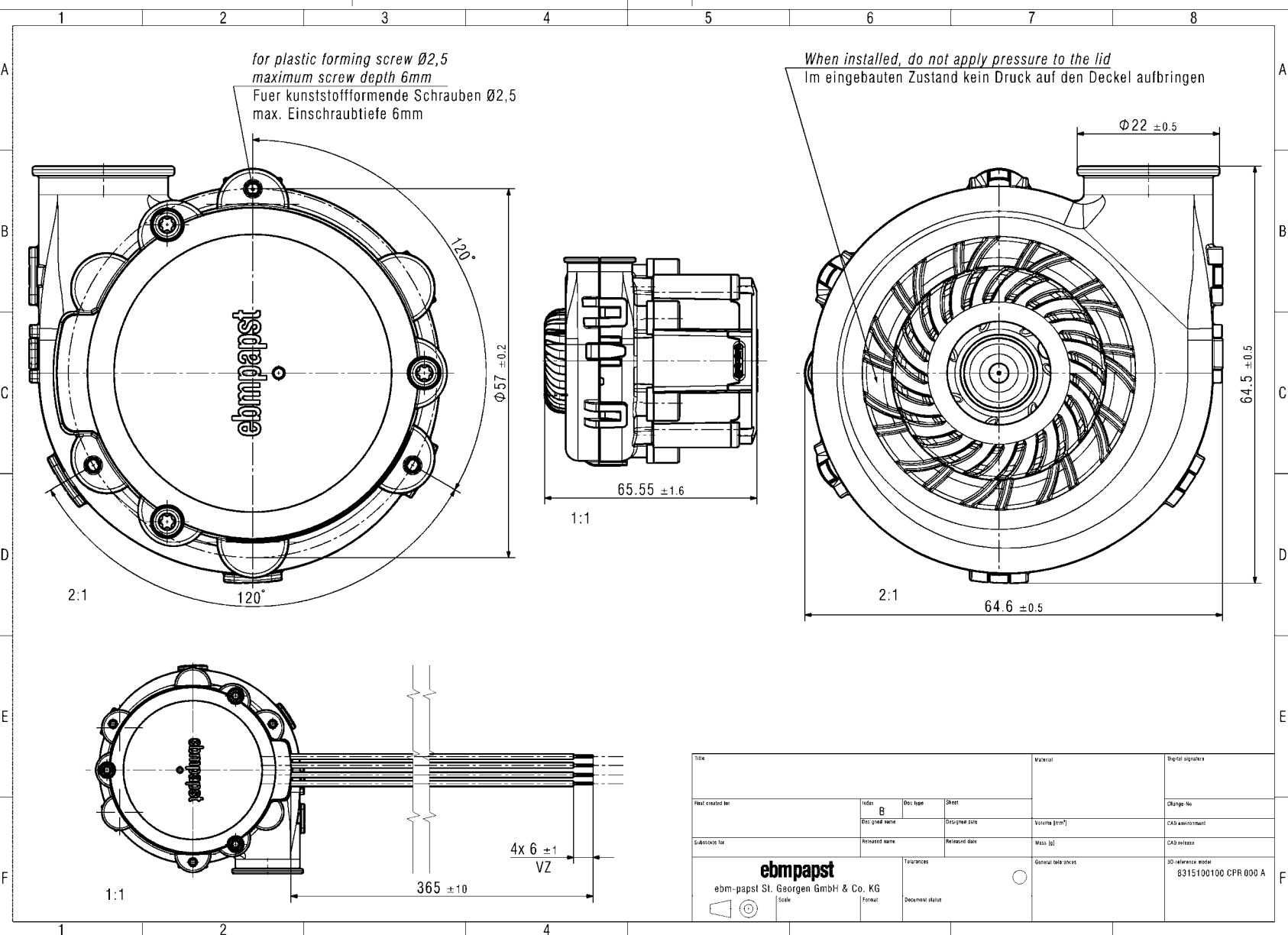

Title				Material		Digital signature	
Part created for		Index	Doc. type	Sheet	Change-No.		
		B			CAD environment		
CAD model name		Design lead		Volume [cm ³]		CAD release	
Substrate for		Released date		Mass [g]			
ebmpapst				Tolerances		General safe zones	
ebm-papst St. Georgen GmbH & Co. KG						3D-reference model	
Scale				Format		8315100100 CPR 000 A	
Document status							