

Product Data Sheet

9594314052

VFS0097XUJCS

RET97-25/14/2TDP-052

ebmpapst

The engineer's choice

RET97-25/14/2TDP-052 (9594314052) ebmpapst Datasheet
sales@fansco.com
www.fansco.com



RET97-25/14/2TDP-052

INDEX

1 General 3

2 Mechanics 3

2.1 General..... 3

2.2 Connections..... 3

3 Operating Data 5

3.1 Electrical Interface - Input..... 5

3.2 Electrical Operating Data 6

3.3 Electrical Interface - Output..... 7

3.4 Electrical Features 8

3.5 Aerodynamics 10

3.6 Sound Data..... 11

4 Environment..... 11

4.1 General..... 11

4.2 Climatic Requirements 11

5 Safety..... 12

5.1 Electrical Safety 12

5.2 Approval Tests 12

6 Reliability..... 12

6.1 General..... 12

1 General

Fan type	Blower without chassis with intake nozzle	
Rotating direction looking at rotor	Clockwise	
Airflow direction	Air in axially, Air out radially	
Bearing system	Ball bearing	
Mounting position - shaft	Any	

2 Mechanics

2.1 General

Depth	40,0 mm	
Diameter	97,0 mm	
Mass	0,43 kg	
Housing material		
Impeller material	Metal	

2.2 Connections

Electrical connection	Wires	
Lead wire length	L = 310 mm	
Tolerance	+ - 10,0 mm	
Tube length	S = 65 mm	
Tolerance	+ - 5,0 mm	

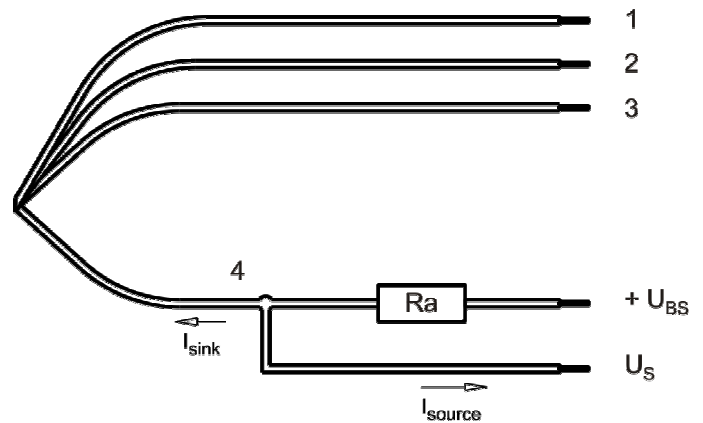

Wire	Color	Operation	Wire size	Insulation diameter
1	red	+ UB	AWG 18	2,2 mm
2	blue	- GND	AWG 18	2,2 mm
3	violet	PWM	AWG 22	1,7 mm
4	white	Tacho	AWG 22	1,7 mm

The auxiliaries shown on the schematic diagram (which are required for the intended use) are not part of our delivery.

3 Operating Data

3.1 Electrical Interface - Input

Control input	PWM
---------------	-----

Features

Input type	Open collector	
PWM - Frequency		1 kHz - 10 kHz typical: 2 kHz

<p>Characteristics</p>	
<p>Schematics</p>	

Speed control:

By Puls width modulation (PWM) 0 ... 100%
 Open collector in relation to signal-ground
 f = 2kHz +/-20%

Information to the curve:

0 % - 7% PWM:	0 1/min
7 % - 10% PWM:	800 1/min (corresponding to min. speed)
10 % - 90% PWM:	linear increasing curve
90 % - 100% PWM:	6.000 1/min (corresponding to max. speed)
7 % PWM:	800 1/min (Fan on, comming from 0% PWM)
5 % PWM:	600 1/min or 0 1/min (Fan off, comming from 100% PWM)

3.2 Electrical Operating Data

Measurement conditions: Normal air density = 1,2 kg/m³; Temperature 23°C +/- 3°C; Motor axis horizontal; warm-up time before measuring 5 minutes (unless otherwise specified).
In the intake and outlet area should not be any solid obstruction within 0,5 m.

$\Delta p = 0$: corresp. to free air flow (see chapter aerodynamics)

I: corresp. to arithm. mean current value

Name	Condition
PWM 0001	PWM: 90 %;

Features	Condition	Symbol	Values		
Voltage range		U	16 V		32,0 V
Nominal voltage		U _N		24,0 V	
Power consumption	$\Delta p = 0$	P	47,6 W	135 W	77 W
Tolerance	PWM 0010		+/- 10 %	+/- 10 %	+/- 10 %
Current consumption	$\Delta p = 0$	I	2.995 mA	5.600 mA	2.400 mA
Tolerance	PWM0010		+/- 10 %	+/- 10 %	+/- 10 %
Speed	$\Delta p = 0$	n	5.100 1/min	6.000 1/min	6.000 1/min
Tolerance	PWM 0010		+/- 5 %	+/- 5 %	+/- 5 %

3.3 Electrical Interface - Output

Tacho type	/2 (open collector)
------------	---------------------

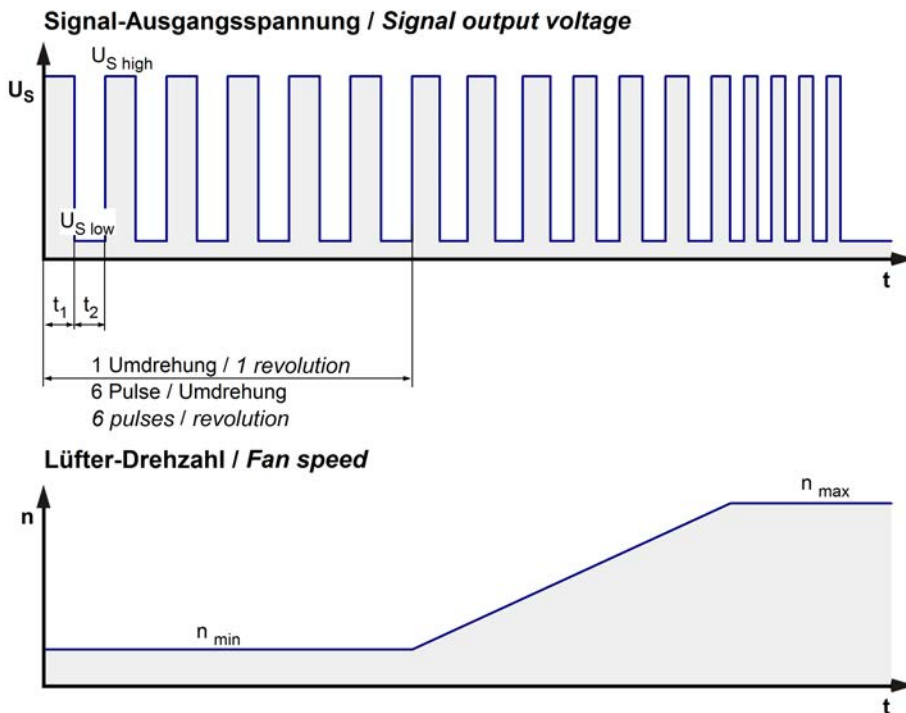

$$R_a = \frac{U_{BS} - U_{S\ low}}{I_{sink}}$$

Lüfter / Fan Kunde / Customer

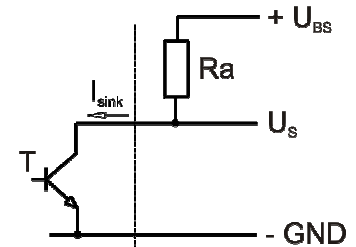

Features	Note	Values
Tacho operating voltage	U_{BS}	$\leq 32\text{ V}$
Tacho signal Low	$U_{S\ low}$	$\leq 0,4\text{ V}$
Tacho signal High	$U_{S\ high}$	$\leq 32\text{ V}$
Maximum sink current	I_{sink}	$\leq 20\text{ mA}$
Maximum source current		0 mA
External resistor	External resistor R_a from U_{BS} to U_s required. All voltages measured to GND.	
Tacho frequency	$(6 \times n) / 60$	600 Hz
Tacho isolated from motor	No	
Slew rate		$\Rightarrow 0,5\text{ V/us}$

n = revolutions per minute (1/min)

Please note:

At zero speed the tacho signal is at a static HIGH. It will be also HIGH when the fan is still spinning, but the speed control signal is set to zero speed already.

The tacho signal is only activated after the start-up is completed.

3.4 Electrical Features

Electronic function	Speed-Controlled	
Reversed polarity protection	N-CH FET	
Max. residual current at U_N	$I_F \leq 5 \text{ mA}$	
Locked rotor protection	Auto restart	
Locked rotor current at U_N	I_{block} approx. 1.700 mA	
Lock signal at locked rotor	t_3 / t_4 typical: 8,2 s / 10 s	



Locked rotor signal t_5 :

After 4 failed start-ups there is an extended timeout of 40 s.

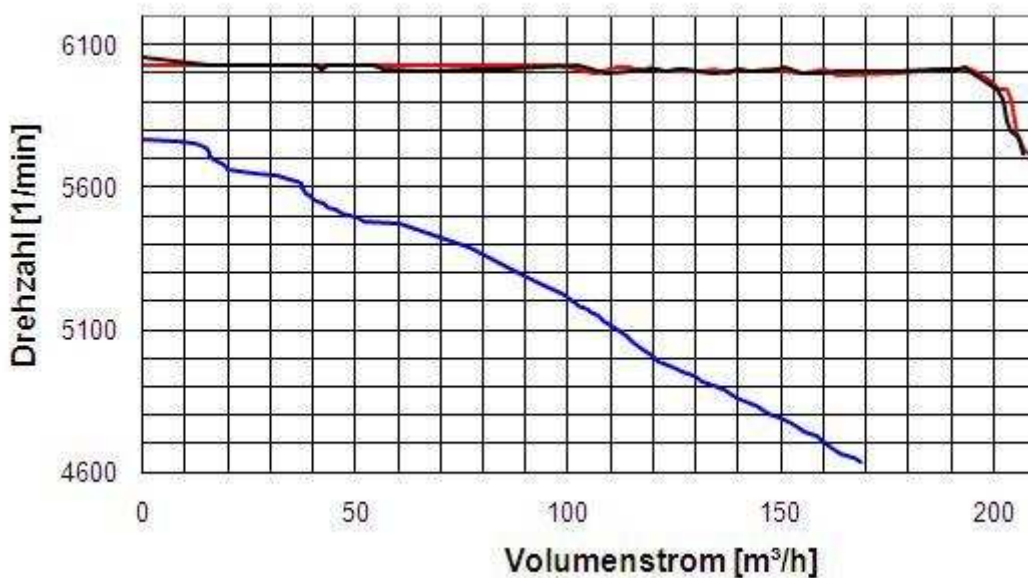

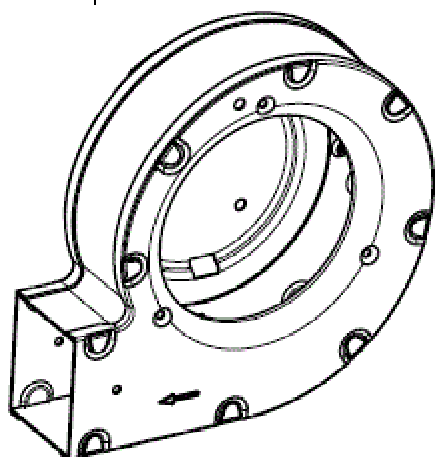

3.5 Aerodynamics

Measurement conditions: Measured with a double chamber intake rig acc. to DIN EN ISO 5801. Normal air density = 1,2 kg/m³; Temperature 23°C +/- 3°C; In the intake and outlet area should not be any solid obstruction within 0,5 m. Motor shaft horizontal. The information is only valid under the specified test conditions and may be changed by the installation conditions. If there are deviations from the standard test conditions, the characteristic values must be checked under the installed conditions.

a.) Operation condition:

5.600 1/min at free air flow	PWM 90 %;		
------------------------------	-----------	--	--

Max. free-air flow ($\Delta p = 0 / \dot{V} = \text{max.}$)	208,0 m ³ /h	
Max. static pressure ($\Delta p = \text{max.} / \dot{V} = 0$)	810 Pa	

The measurements were taken in the volute housing of G2S097-... The speed at free air is at 24 V approx. 5.700 1/min.

at free air flow	
at free air flow	

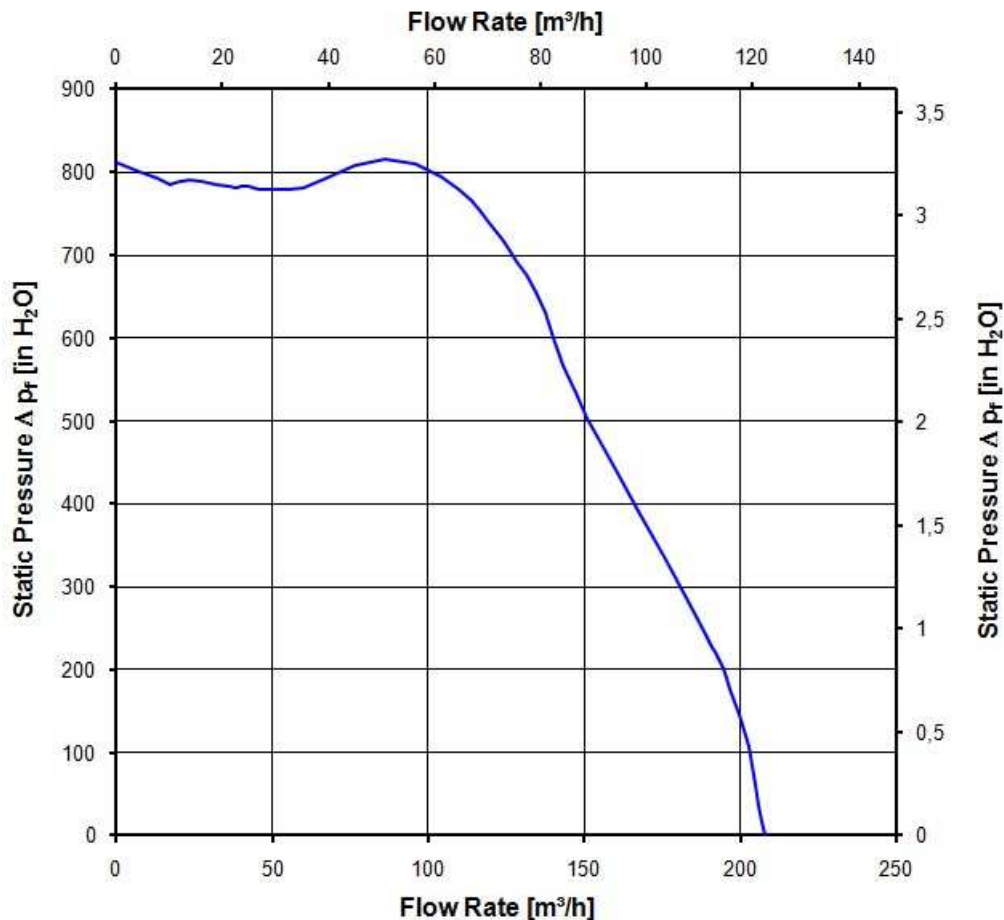

3.6 Sound Data

Measurement conditions: Sound pressure level: 1 meter distance between microphone and the air intake.
Sound power level: Acc. to DIN 45635 part 38 (ISO 10302)
Measured in a semianchoic chamber with a background noise level of $L_p(A) < 5 \text{ dB(A)}$
For further measurement conditions see chapter aerodynamics.

a.) Operation condition:

5.600 1/min at free air flow	PWM 90 %;		
------------------------------	-----------	--	--

Optimal operating point	115,0 m ³ /h @ 658 Pa	
Sound power level at the optimal operating point	8,2 bel(A)	
Sound pressure level at free air flow, measured in rubber bands		
at free air flow		
at free air flow		

4 Environment

4.1 General

Min. permitted ambient temperature TU min.	-20 °C	
Max. permitted ambient temperature TU max.	60 °C	
Min. permitted storage temperature TL min.	-40 °C	
Max. permitted storage temperature TL max.	80 °C	

4.2 Climatic Requirements

Humidity requirements	humid heat, constant; according to DIN EN 60068-2-78, 14 days	
Water exposure	None	
Dust requirements	None	
Salt fog requirements	None	

Permitted application area:

The product is intended for use in sheltered rooms with controlled temperature and controlled humidity. Directly exposure to water must be avoided.

Pollution degree 1 (according DIN EN 60664-1)

There is either no pollution or it occurs only dry, non-conductive pollution. The pollution has no negative impact.

Please require severity levels and specification parameters from the responsible development departments.

5 Safety

5.1 Electrical Safety

Dielectric strength DIN EN 60950 (VDE 0805) and DIN EN 60335 (VDE 0700) A.) Type test Measuring conditions: After 48h of storage at 95% R.H. and 25°C. No arcing or breakdown is allowed! All connections together to ground.	500 VAC / 1 Min.	
B.) Routine test Measuring conditions: At indoor climate. No arcing or breakdown is allowed! All connections together to ground.	850 VDC / 1 Sec.	
Isolation resistance Measuring conditions: After 48h of storage at 95% R.H. and 25°C measured with U=500 VDC for 1 min.	RI > 10 MOhm	
Clearance / creepage distance	1,0 mm / 1,2 mm	
Protection class	III	

5.2 Approval Tests

CE	EC Declaration of Conformity	No
EAC	Eurasian Conformity	Yes
UL	Underwriters Laboratories	Yes / UL507, Electric Fans E38324
VDE	Association for Electrical, Electronic and Information Technologies	Yes / Approval acc. to EN 60950 (VDE 0805) - Information technology equipment
CSA	Canadian Standards Association	Yes / C22.2 No. 113 Fans and Ventilators
CCC	China Compulsory Certification	Not applicable

6 Reliability

6.1 General

--	--	--

Copying of this document, and giving it others and the use or communication of the contents thereof, are forbidden without express written consent of the manufacturer. All rights are reserved.

Scale: 1:1
 Refer to production notes DIN ISO 8015 (2015-01)

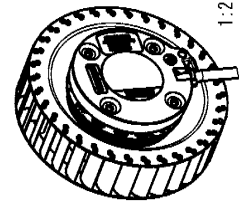
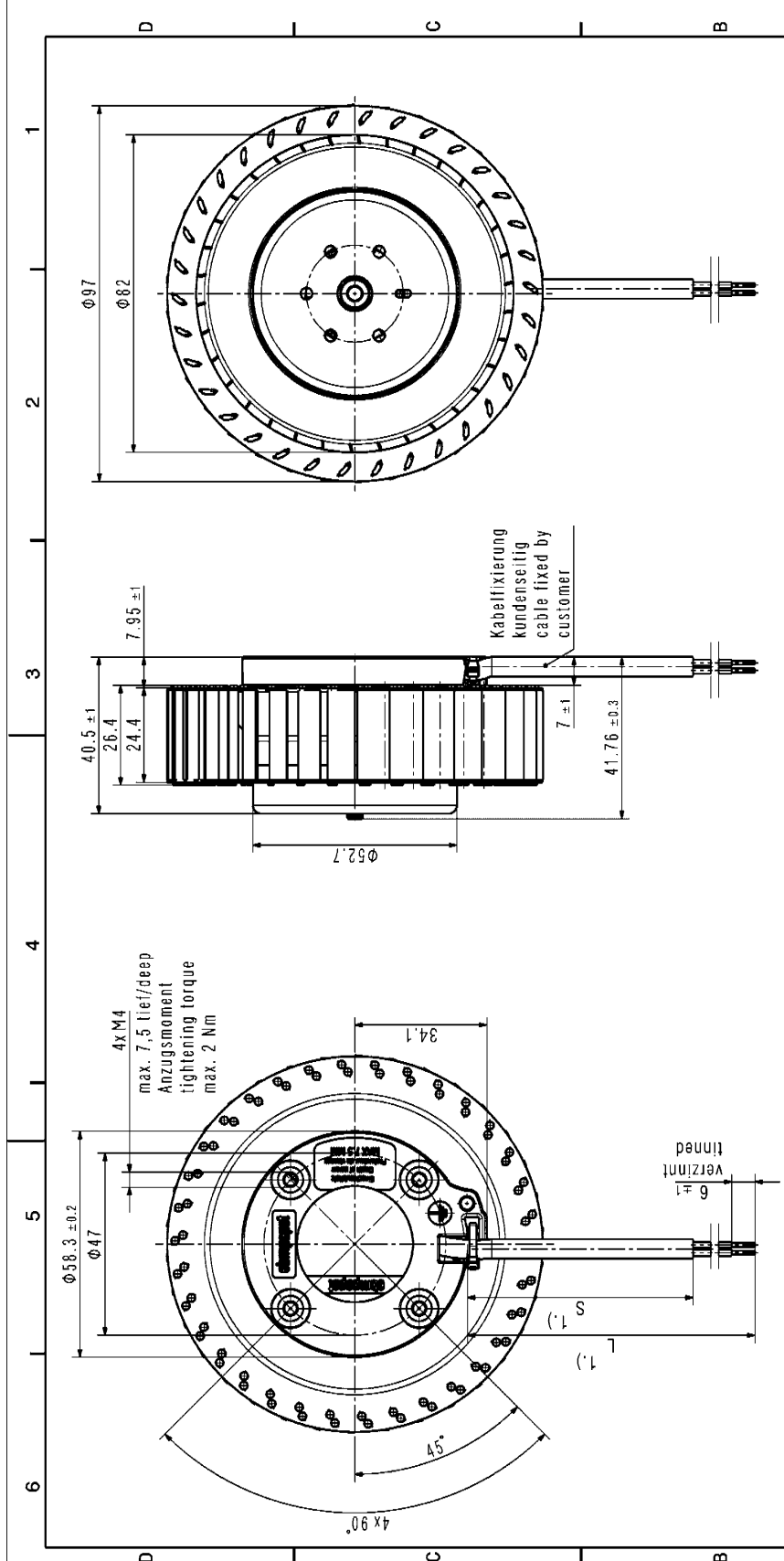

- 1.) Anzahl und Länge der Litzen sowie Länge des Schlauches siehe Produktspezifikation
- Axialspiel der Kugellager mit Feder spielfrei gelagert
- 1.) length and number of wires and length of tube see design specification
- ball bearing without clearance by a pre-load spring

Dokument Status / Document Status Approved / Genehmigt Change No. / Änderung Nr.		CAD / Version / Date / Version / Datum 899414052 / 01 / 01 / 2015		Hersteller / Manufacturer ebmpapst		Volumen / Volume (m³) / Gewicht / Mass (kg)	
Zeichnung / Drawing 899414052		ID: Referenzmodell / ID: Reference Model 899414052		Artikel / Title RET97-25/14/2TDP-052		ERS / Zeich. / Revision 01 / 01 / 01	
Abmessungen / Dimensions 40.5 ± 1 26.4 24.4 7.95 ± 1 7 ± 1 41.76 ± 0.3 Ø52.7 Ø58.3 ± 0.2 Ø47 Ø82 Ø97		Name ebmpapst		Zeichnung / Drawing RET97-25/14/2TDP-052		Form / Size 1.2	