

RER175-42/18/2TDMLP (9595414600) ebmpapst Datasheet  
sales@fansco.com  
www.fansco.com

**Product Data Sheet**    **9595414600**  
VBS0175XULCS  
RER175-  
42/18/2TDMLP

**ebmpapst**

engineering a better life



RER175-42/18/2TDMLP

INDEX

- 1 General ..... 3**
- 2 Mechanics ..... 3**
  - 2.1 General ..... 3
  - 2.2 Connections ..... 3
- 3 Operating Data ..... 5**
  - 3.1 Electrical Interface - Input ..... 5
  - 3.2 Electrical Operating Data ..... 6
  - 3.3 Electrical Interface - Output ..... 7
  - 3.4 Electrical Features ..... 8
  - 3.5 Aerodynamics ..... 9
  - 3.6 Sound Data ..... 10
- 4 Environment ..... 10**
  - 4.1 General ..... 10
  - 4.2 Climatic Requirements ..... 10
  - 4.3 Mechanical Requirements ..... 11
- 5 Safety ..... 12**
  - 5.1 Electrical Safety ..... 12
  - 5.2 Approval Tests ..... 12
- 6 Reliability ..... 12**
  - 6.1 General ..... 12

**1 General**

Fan type	Blower without chassis with intake nozzle	
Rotating direction looking at rotor	Clockwise	
Airflow direction	Axial: intake; centrifugal: exhaust	
Bearing system	Ball bearing	
Mounting position - shaft	Any	

**Please note:**

"Sensorless commutation electronic, starting at the first start may not be 100% guaranteed, automatic restart occurs."

**2 Mechanics**

**2.1 General**

Depth	69 mm	
Diameter	175 mm	
Mass	0,775 kg	
Housing material		
Impeller material	Plastic	

**2.2 Connections**

Electrical connection	Wires	
Lead wire length	L = 425 mm	
Tolerance	+ - 10 mm	
Tube length	S = 115 mm	
Tolerance	+ - 5,0 mm	

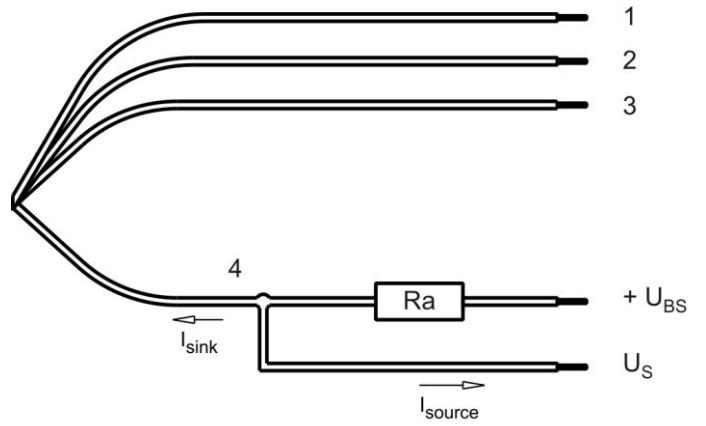

Wire	Color	Operation	Wire size	Insulation diameter
1	red	+ UB	AWG 22	1,7 mm
2	blue	- GND	AWG 22	1,7 mm
3	violet	PWM	AWG 22	1,7 mm
4	white	Tacho	AWG 22	1,7 mm

The auxiliaries shown on the schematic diagram (which are required for the intended use) are not part of our delivery.

3 Operating Data

3.1 Electrical Interface - Input

Control input	PWM
---------------	-----

Features

Input type	Open collector	
PWM - Frequency		1 kHz - 10 kHz typical: 2 kHz

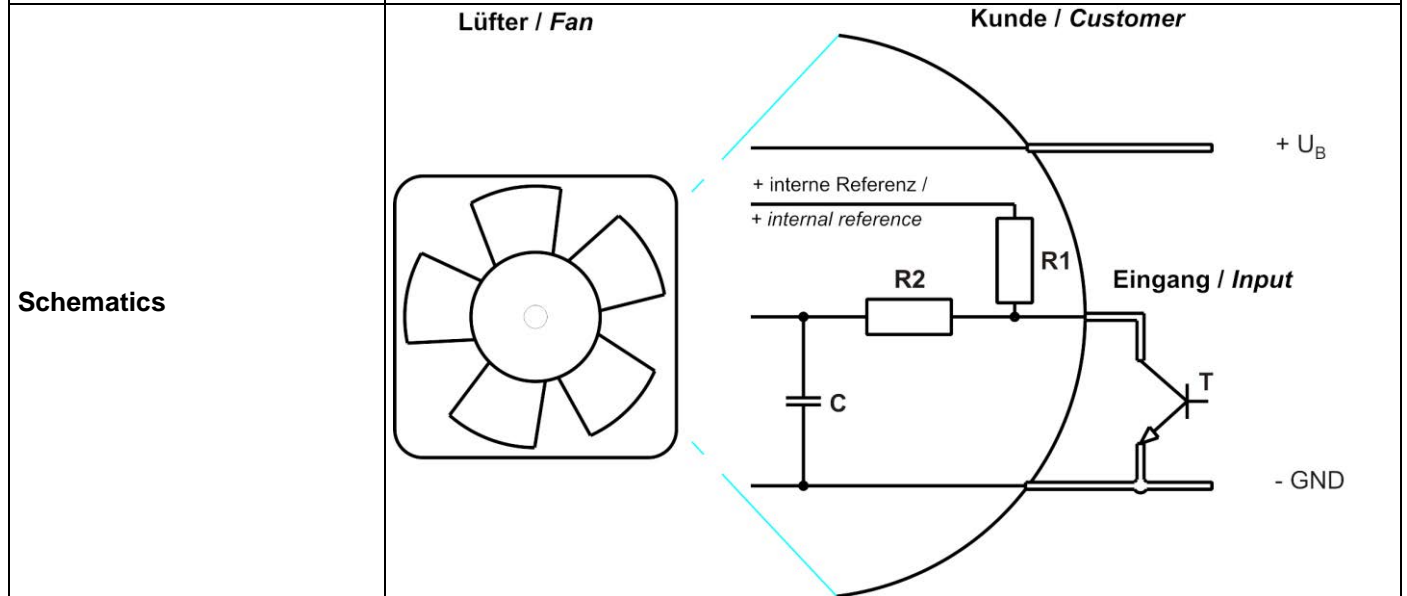
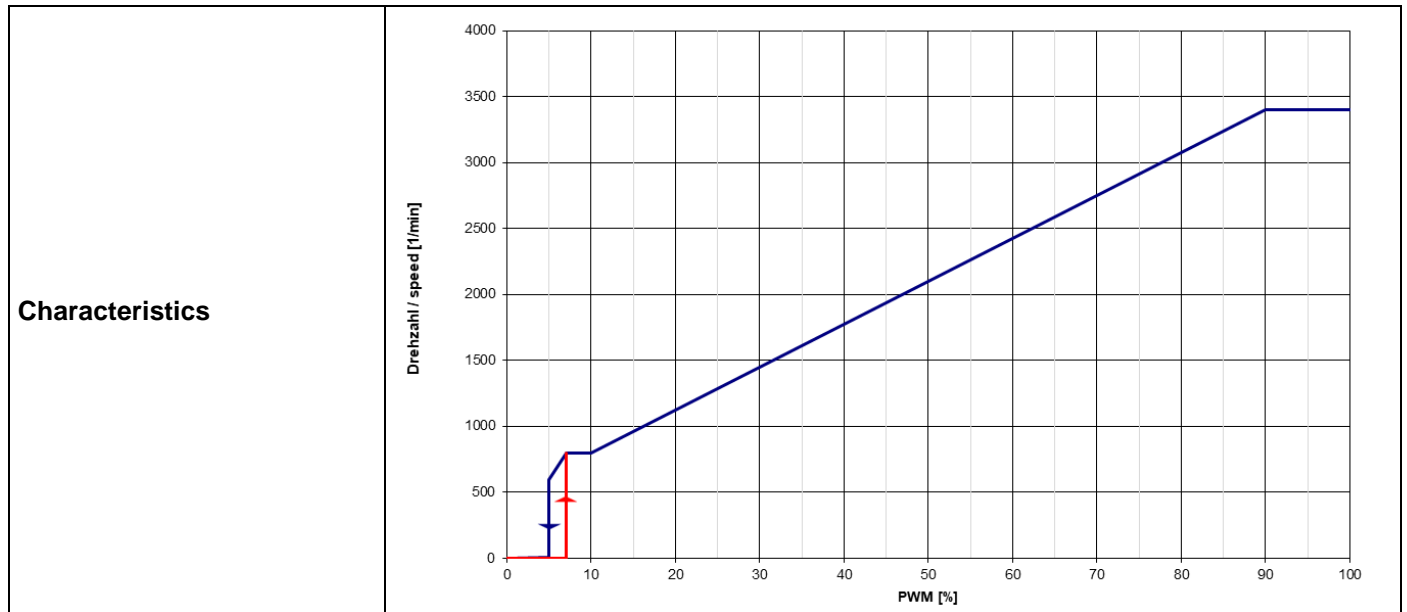

The shown pull-up resistor R1 to the internal reference voltage (+5V) has 4.7 kOhm.

**Speed control:**

By Puls width modulation (PWM) 0 ... 100%  
Open collector in relation to signal-ground

Transistor requirements:

VCE max.  $\geq$  12V; Isink max  $>$  5mA; VCEsat  $<$  0,15V

**Information to the curve:**

0 % - 7% PWM:	0 1/min
7 % PWM:	800 1/min (Fan on, comming from 0% PWM)
7 % - 10% PWM:	800 1/min (corresponding to min. speed)
10 % - 90% PWM:	linear increasing curve
90 % - 100% PWM:	3.400 1/min (corresponding to max. speed)
7 % - 5 % PWM:	linear decreasing curve (comming from 100% PWM)
5 % PWM:	600 1/min or 0 1/min (Fan off, comming from 100% PWM)

**3.2 Electrical Operating Data**

Measurement conditions: Normal air density = 1,2 kg/m<sup>3</sup>; Temperature 23°C +/- 3°C; Motor axis horizontal; warm-up time before measuring 5 minutes (unless otherwise specified).  
In the intake and outlet area should not be any solid obstruction within 0,5 m.

Measurement setup:	Measured between two steel plates
Steel plate:	207 mm x 207 mm
Intake nozzle:	D: 125,5 mm; R: 10 mm
Distance between bottom and top plate:	79,75 mm
Overlapping impeller / nozzle:	2 mm

$\Delta p = 0$ : corresp. to free air flow (see chapter aerodynamics)

I: corresp. to arithm. mean current value

Name	Condition
PWM 0001	PWM: 100 %; f: 2 kHz

**100% PWM or broken lead wire (open control input)**

Features	Condition	Symbol	Values		
Voltage range		U	36 V		57,0 V
Nominal voltage		U <sub>N</sub>		48,0 V	
Power consumption	$\Delta p = 0$	P	47 W	46 W	51 W
Tolerance	PWM 0010		+/- 10,0 %	+/- 10,0 %	+/- 10,0 %
Current consumption	$\Delta p = 0$	I	1.300 mA	950 mA	900 mA
Tolerance	PWM0010		+/- 10,0 %	+/- 10,0 %	+/- 10,0 %
Speed	$\Delta p = 0$	n	3.400 1/min	3.400 1/min	3.400 1/min
Tolerance	PWM 0010		+/- 10,0 %	+/- 10,0 %	+/- 10,0 %

3.3 Electrical Interface - Output

Tacho type	/2 (open collector)
------------	---------------------

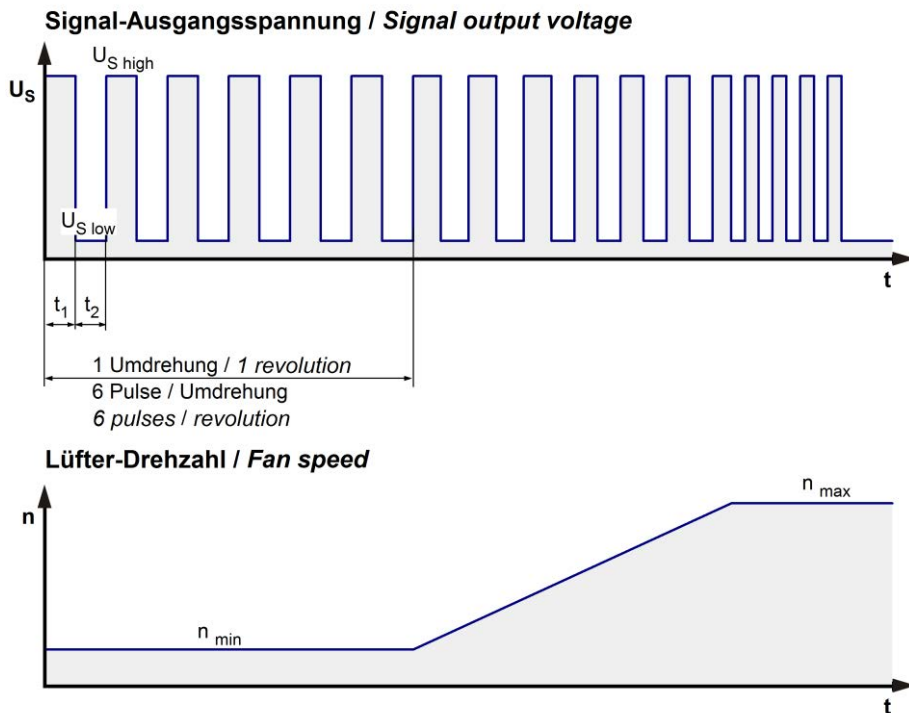

$$R_a = \frac{U_{BS} - U_{S\ low}}{I_{sink}}$$

Lüfter / Fan      Kunde / Customer

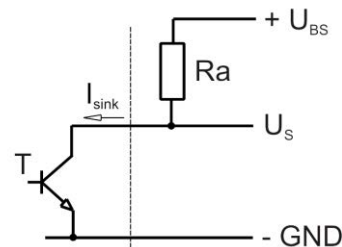

Features	Note	Values
Tacho operating voltage	$U_{BS}$	$\leq 60\ V$
Tacho signal Low	$U_{S\ low}$	$\leq 0,4\ V$
Tacho signal High	$U_{S\ high}$	$\leq 60,0\ V$
Maximum sink current	$I_{sink}$	$\leq 20\ mA$
External resistor	External resistor $R_a$ from $U_{BS}$ to $U_s$ required. All voltages measured to GND.	
Tacho frequency	$(6 \times n) / 60$	340 Hz @ 3.400 1/min
Tacho isolated from motor	No	
Slew rate		$\geq 0,5\ V/\mu s$

n = revolutions per minute (1/min)

3.4 Electrical Features

Electronic function	Speed-Controlled	
Reversed polarity protection	Rectifying diode	
Max. residual current at $U_N$	$I_F \leq 5 \text{ mA}$	
Locked rotor protection	Auto restart	
Locked rotor current at $U_N$	$I_{block}$ approx. 2.200 mA	
Clock signal at locked rotor	$t_3 / t_4$ typical: 7 s / 10,0 s	
Extended Downtime	$t_5$ : 40,0 s after 4 start-up tests	
Internal fuse	Littelfuse NANO2 > Very Fast-Acting > 451/453 Series 2,5A / 125V (Art.No.: 045102.5MRL)	
Voltage control *)	Fan turns on at $U_B > 32 \text{ V}$ or $< 66 \text{ V}$ Fan turns off at $U_B < 30 \text{ V}$ or $> 68 \text{ V}$	

\*) This fan has an undervoltage and overvoltage control circuit integrated which turns the motor off if the voltage is out of range.

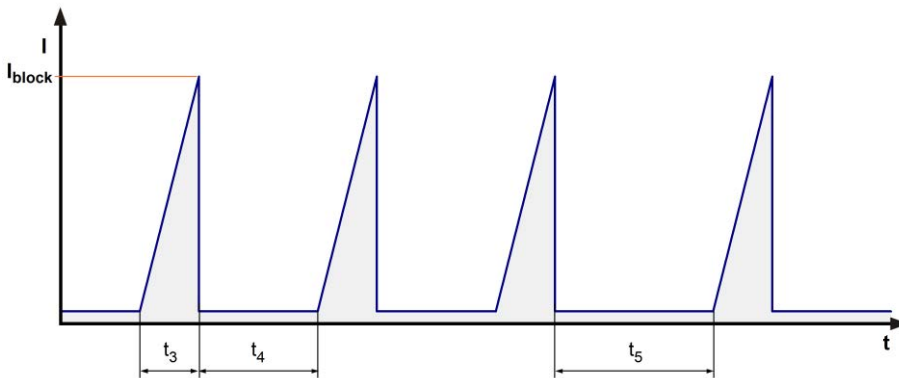

3.5 Aerodynamics

Measurement conditions: Measured with a double chamber intake rig acc. to DIN EN ISO 5801. Normal air density = 1,2 kg/m<sup>3</sup>; Temperature 23°C +/- 3°C; In the intake and outlet area should not be any solid obstruction within 0,5 m. Motor shaft horizontal.

The information is only valid under the specified test conditions and may be changed by the installation conditions. If there are deviations from the standard test conditions, the characteristic values must be checked under the installed conditions. Power consumption of the fan motor when operating at normal voltage is shown. Depending on the operating conditions of the application, the power input may be higher.

Measurement setup:	Measured between two steel plates
Steel plate:	207 mm x 207 mm
Intake nozzle:	D: 125,5 mm; R: 10 mm
Distance between bottom and top plate:	79,75 mm
Overlapping impeller / nozzle:	2 mm

a.) Operation condition:

3.400 1/min at free air flow	PWM 100 %; f: 2 kHz		
------------------------------	---------------------	--	--

Max. free-air flow ( $\Delta p = 0 / \dot{V} = \text{max.}$ )	605 m <sup>3</sup> /h	
Max. static pressure ( $\Delta p = \text{max.} / \dot{V} = 0$ )	390 Pa	

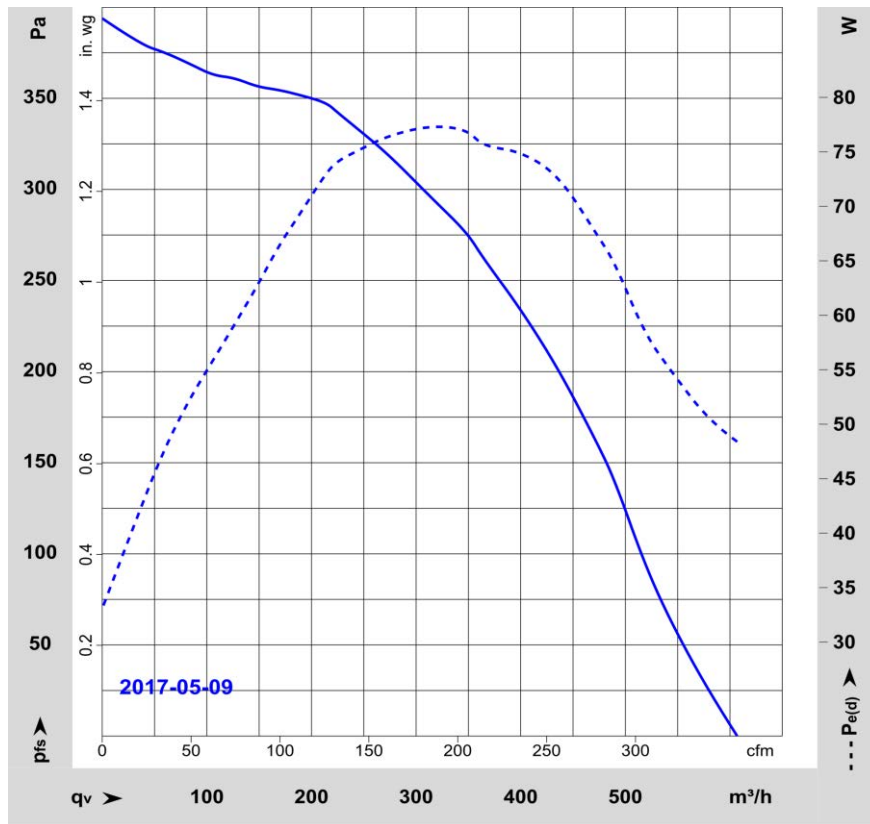

**3.6 Sound Data**

Measurement conditions: Sound pressure level: 1 meter distance between microphone and the air intake.  
 Sound power level: Acc. to DIN 45635 part 38 (ISO 10302)  
 Measured in a semianechoic chamber with a background noise level of  $L_p(A) < 5 \text{ dB(A)}$   
 For further measurement conditions see chapter aerodynamics.

a.) Operation condition:

3.400 1/min at free air flow	PWM 100 %; f: 2 kHz		
------------------------------	---------------------	--	--

Optimal operating point	435 m <sup>3</sup> /h @ 198 Pa		
Sound power level at the optimal operating point	7,3 bel(A)		
Sound pressure level at free air flow, measured in rubber bands			

**4 Environment**

**4.1 General**

Min. permitted ambient temperature TU min.	-20 °C		
Max. permitted ambient temperature TU max.	65 °C		
Min. permitted storage temperature TL min.	-40 °C		
Max. permitted storage temperature TL max.	80 °C		

**4.2 Climatic Requirements**

Humidity requirements	humid heat, constant; according to DIN EN 60068-2-78, 14 days		
Water exposure	None		
Dust requirements	None		
Salt fog requirements	None		

Permitted application area:

The product is intended for use in sheltered rooms with controlled temperature and controlled humidity. Directly exposure to water must be avoided.

Pollution degree 1 (according DIN EN 60664-1)

There is either no pollution or it occurs only dry, non-conductive pollution. The pollution has no negative impact.

## 4.3 Mechanical Requirements

severity level	Vibration (sinusoidal)	
2 G	Vibration (sinusoidal) in use IEC 60068-2-6 Displacement / frequency range Acceleration / frequency range Sweep rate Sweep cycles Duration Axes of vibration	Vibration (sinusoidal) 0,15 mm / 10-58, 58-10 Hz 2 G / 58-500-58 Hz 1 Oct./min 10 2 hrs. 3

severity level	stationary use		
1	storage / transportation	Random vibration not in use IEC 60068-2-64 Frequency range / ASD  G <sub>RMS</sub> Axes of vibration Test duration	Random vibration 5 - 20 Hz : 1,0 m <sup>2</sup> / s <sup>3</sup> 20 - 500 Hz : - 3 dB / Oct 0,91 G 3 3 x 5 h
	storage / transportation	Bump not in use IEC 60068-2-29 Shock spectrum Acceleration Duration Number of bumps (+X, -X, -Y, +Y, -Z, +Z) Total bumps	Bump half sine 18 G 6 ms 100 in each direction 600
	stationary use	Random vibration in use IEC 60068-2-64 Frequency range / ASD  G <sub>RMS</sub> Axes of vibration Test duration	Random vibration 5 - 20 Hz : 2,0 m <sup>2</sup> / s <sup>3</sup> 20- 150 Hz : - 3 dB / Oct 0,83 G 3 3 x 5 h
	stationary use	Bump in use IEC 60068-2-29 Shock spectrum Acceleration Duration Number of bumps (+X, -X, -Y, +Y, -Z, +Z) Total bumps	Bump half sine 5 G 11 ms 100 in each direction 600

**5 Safety****5.1 Electrical Safety**

Dielectric strength DIN EN 62368 and DIN EN 60335 A.) Type test Measuring conditions: After 48h of storage at 95% R.H. and 25°C. No arcing or breakdown is allowed! All connections together to ground. B.) Routine test Measuring conditions: At indoor climate. No arcing or breakdown is allowed! All connections together to ground.	500 VAC / 1 Min.  850 VDC / 1 Sec.	
Isolation resistance Measuring conditions: After 48h of storage at 95% R.H. and 25°C measured with U=500 VDC for 1 min.	RI > 10 MOhm	
Clearance / creepage distance	1,0 mm / 1,5 mm	
Protection class	III	

**5.2 Approval Tests**

CE	EC Declaration of Conformity	No
EAC	Eurasian Conformity	Yes
UL	Underwriters Laboratories	Yes / UL507, Electric Fans E38324
VDE	Association for Electrical, Electronic and Information Technologies	Yes / Approval acc. to EN 62368 - Audio/video, information and communication technology equipment
CSA	Canadian Standards Association	Yes / C22.2 No. 113 Fans and Ventilators
CCC	China Compulsory Certification	Yes / GB 12350 Safety Requirements for small Power Motors

**6 Reliability****6.1 General**

Life expectancy L10 at TU = 40 °C	72.500 h	
Life expectancy L10 at TU max.	40.000 h	
Life expectancy L10 acc. to IPC 9591 at TU = 40 °C	122.500 h	

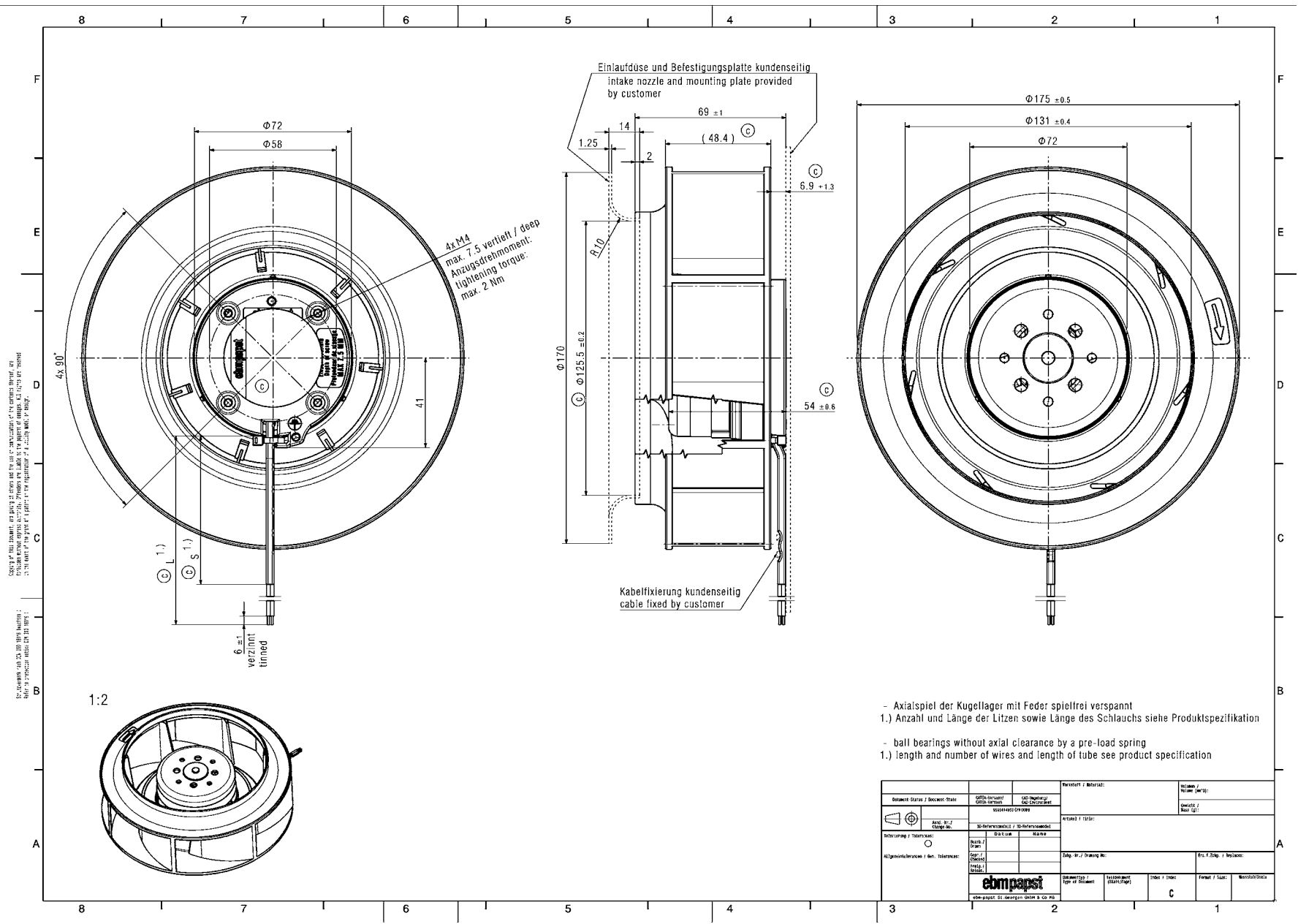

Copyright © 2015 ebmpapst. All rights reserved. This document is the property of ebmpapst. All rights reserved. No part of this document may be reproduced without the prior written permission of ebmpapst.

- Axialspiel der Kugellager mit Feder spielfrei verspannt  
1.) Anzahl und Länge der Litzen sowie Länge des Schlauchs siehe Produktspezifikation
- ball bearings without axial clearance by a pre-load spring  
1.) length and number of wires and length of tube see product specification

ebmpapst ebmpapst St. Georgen GmbH & Co. KG		Revision / Version: 01.000 (Rev. 01)	
Drawing / Zeichnung: RER175-42/18/2TDMLP		Title / Titel: Motor	
Part / Bauteil: RER175-42/18/2TDMLP		Date / Datum: 01.01.2015	
Drawing / Zeichnung: RER175-42/18/2TDMLP		Drawing / Zeichnung: RER175-42/18/2TDMLP	
Drawing / Zeichnung: RER175-42/18/2TDMLP		Drawing / Zeichnung: RER175-42/18/2TDMLP	