

Product Data Sheet **9595414520**
VBS0133XULCS
RER133-41/14/2DMP

RER133-41/14/2DMP (9595414520) ebmpapst Datasheet sales@fansco.com www.fansco.com

ebmpapst

engineering a better life



RER133-41/14/2DMP (9595414520) ebmpapst Datasheet sales@fansco.com www.fansco.com

RER133-41/14/2TDMP

INDEX

- 1 General 3**
- 2 Mechanics 3**
 - 2.1 General 3
 - 2.2 Connections 3
- 3 Operating Data 5**
 - 3.1 Electrical Interface - Input 5
 - 3.2 Electrical Operating Data 6
 - 3.3 Electrical Interface - Output 7
 - 3.4 Electrical Features 8
 - 3.5 Aerodynamics 9
 - 3.6 Sound Data 10
- 4 Environment 10**
 - 4.1 General 10
 - 4.2 Climatic Requirements 10
- 5 Safety 11**
 - 5.1 Electrical Safety 11
 - 5.2 Approval Tests 11
- 6 Reliability 11**
 - 6.1 General 11

1 General

Fan type	Blower without chassis with intake nozzle	
Rotating direction looking at rotor	Clockwise	
Airflow direction	Air in axially, Air out radially	
Bearing system	Ball bearing	
Mounting position - shaft	Any	

Please note:

"Sensorless commutation electronic, starting at the first start may not be 100% guaranteed, automatic restart occurs."

2 Mechanics

2.1 General

Depth	91,0 mm	
Diameter	133,0 mm	
Mass	0,890 kg	
Housing material		
Impeller material	Plastic	

2.2 Connections

Electrical connection	Wires	
Lead wire length	L = 425 mm	
Tolerance	+/- 10 mm	
Tube length	S = 115 mm	
Tolerance	+/- 5,0 mm	
Wire size (AWG)	22	
Insulation diameter	1,70 mm	

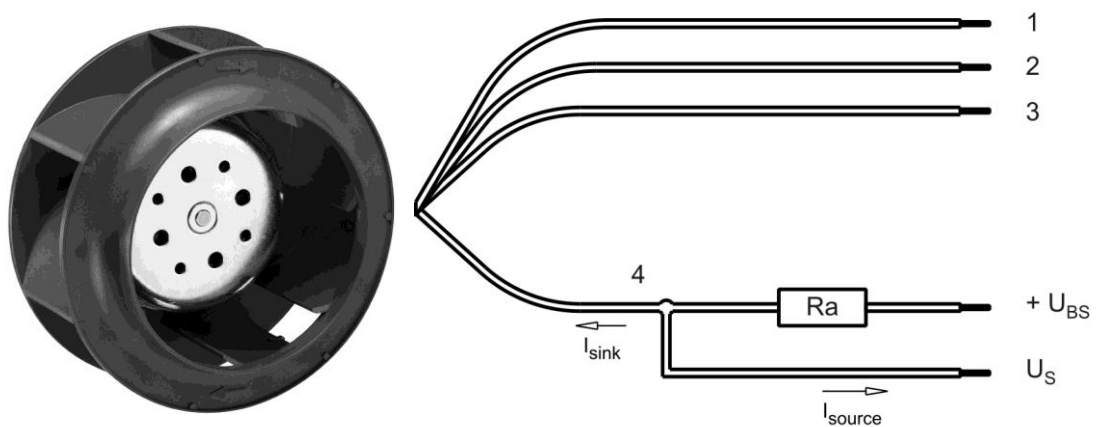

Wire	Color	Operation
1	red	+ UB
2	blue	- GND
3	violet	PWM
4	white	Tacho

The auxiliaries shown on the schematic diagram (which are required for the intended use) are not part of our delivery.

3 Operating Data

3.1 Electrical Interface - Input

Control input	PWM
---------------	-----

Features

Input type	Open collector	
PWM - Frequency		1 kHz - 20 kHz typical: 2 kHz

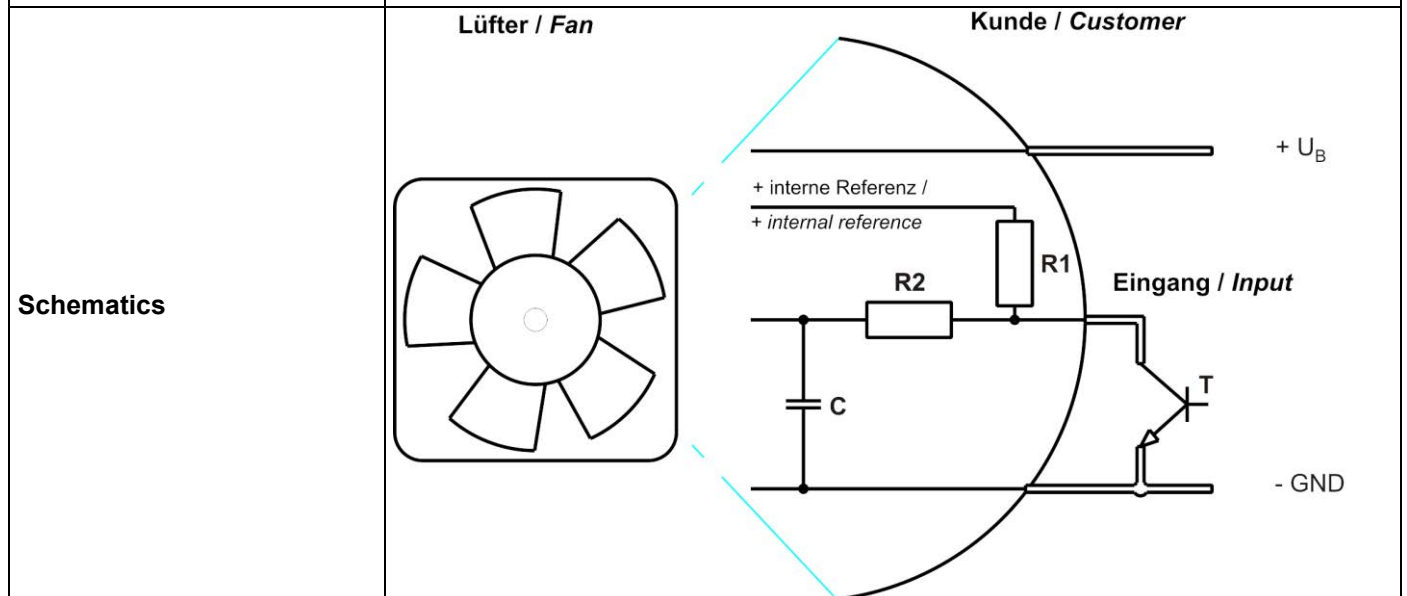
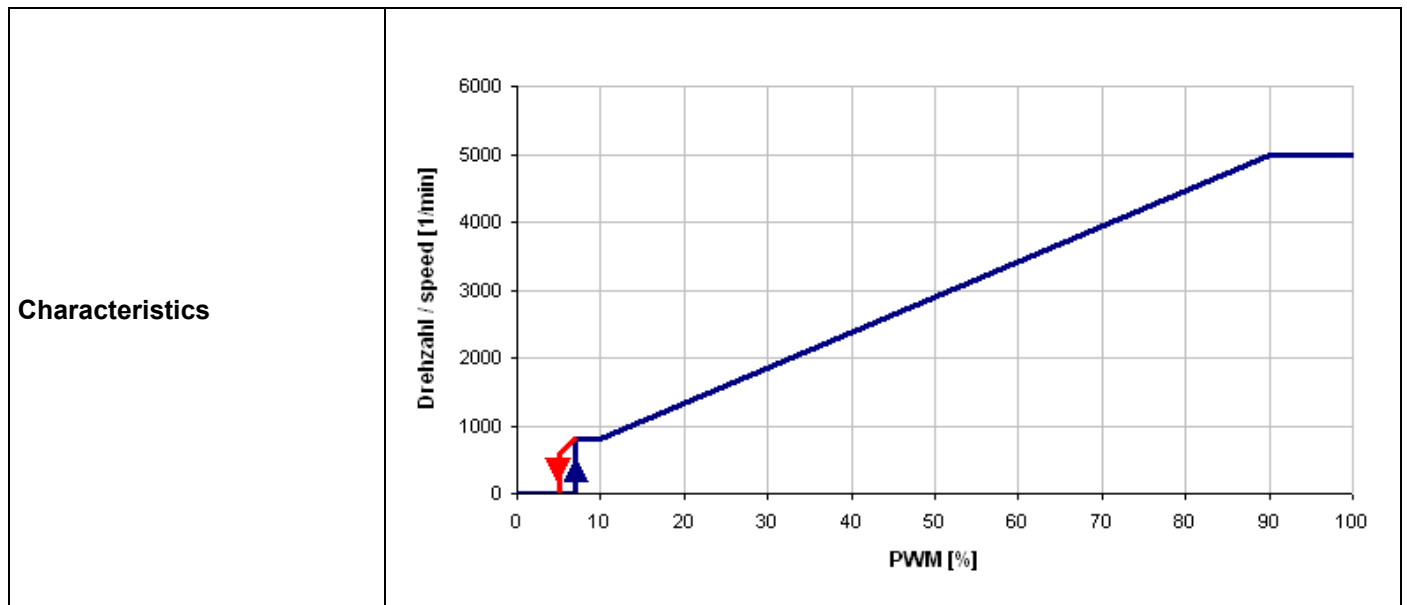

Speed control:
 By Puls width modulation (PWM) 0 ... 100%
 Open collector in relation to signal-ground

Please note:

It's possible to control the fan by a control voltage of 0... 5 V. (5 V corresponds to 100 % PWM).

The power supply must be able to "sink" and works together with an internal pull-up resistor (4,7 kOhm).

Information to the curve:

0 % - 7% PWM:	0 1/min
7 % PWM:	800 1/min (Fan on, comming from 0% PWM)
7 % - 10% PWM:	800 1/min (corresponding to min. speed)
10 % - 90% PWM:	linear increasing curve
90 % - 100% PWM:	5.000 1/min (corresponding to max. speed)
7 % - 5 % PWM:	linear decreasing curve (comming from 100% PWM)
5 % PWM:	600 1/min or 0 1/min (Fan off, comming from 100% PWM)

3.2 Electrical Operating Data

Measurement conditions: Normal air density = 1,2 kg/m³; Temperature 23°C +/- 3°C; Motor axis horizontal; warm-up time before measuring 5 minutes (unless otherwise specified).
In the intake and outlet area should not be any solid obstruction within 0,5 m.

Measurement setup:	Measured between two steel plates
Steel plate:	140 mm x 140 mm
Intake nozzle:	D: 87 mm; R: 7 mm
Distance between bottom and top plate:	101 mm
Overlapping impeller / nozzle:	2 mm

$\Delta p = 0$: corresp. to free air flow (see chapter aerodynamics)

I: corresp. to arithm. mean current value

Name	Condition
PWM 0001	PWM: 95 %; f: 2 kHz

100% PWM; f = 2 kHz or broken lead wire (open control input)

The data at 50% PWM are no FK features and need not be tested.

Features	Condition	Symbol	Values		
Voltage range		U	16 V		30 V
Nominal voltage		U _N		24,0 V	
Power consumption	$\Delta p = 0$	P	38,4 W	58,0 W	60,5 W
Tolerance	PWM 0010		+ - 10 %	+ - 10 %	+ - 10 %
Current consumption	$\Delta p = 0$	I	2.400 mA	2.400 mA	2.000 mA
Tolerance	PWM0010		+ - 10 %	+ - 10 %	+ - 10 %
Speed	$\Delta p = 0$	n	4.330 1/min	5.000 1/min	5.000 1/min
Tolerance	PWM 0010		+ - 7,5 %	+ - 5 %	+ - 5 %

3.3 Electrical Interface - Output

Tacho type	/2 (open collector)
------------	---------------------

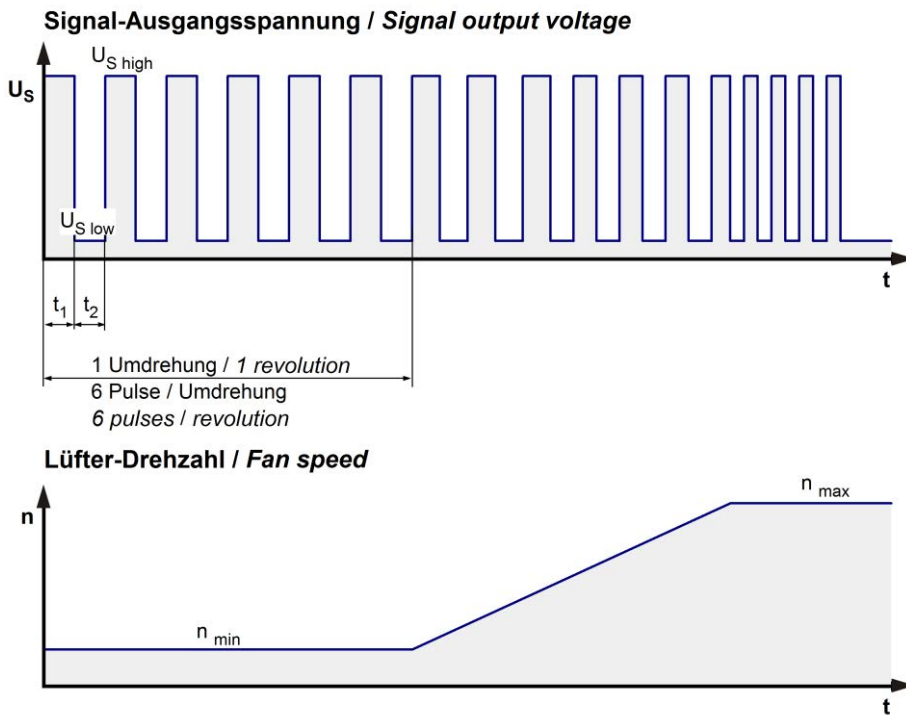

$$R_a = \frac{U_{BS} - U_{S\ low}}{I_{sink}}$$

Lüfter / Fan Kunde / Customer

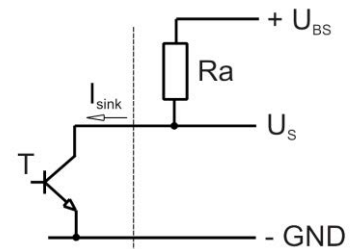

Please note:

At zero speed the tacho signal is at a static HIGH. It will be also HIGH when the fan is still spinning, but the speed control signal is set to zero speed already.
 The tacho signal is only activated after the start-up is completed.

Features	Note	Values
Tacho operating voltage	U_{BS}	$\leq 60,0\ V$
Tacho signal Low	$U_{S\ low}$	$\leq 0,4\ V$
Tacho signal High	$U_{S\ high}$	$\leq 60,0\ V$
Maximum sink current	I_{sink}	$\leq 20\ mA$
External resistor	External resistor R_a from U_{BS} to U_S required. All voltages measured to GND.	
Tacho frequency	$(6 \times n) / 60$	
Tacho isolated from motor	No	
Slew rate		$\Rightarrow 0,5\ V/\mu s$

n = revolutions per minute (1/min)

Note to the tacho-frequency: (6 Pulse per revolution!)

3.4 Electrical Features

Electronic function	Speed-Controlled	
Reversed polarity protection	Rectifying diode	
Max. residual current at U_N	$I_F \leq 5 \text{ mA}$	
Locked rotor protection	Auto restart	
Locked rotor current at U_N	I_{block} approx. 3.200 mA	
Clock signal at locked rotor	t_3 / t_4 typical: 6,3 s / 10,0 s	

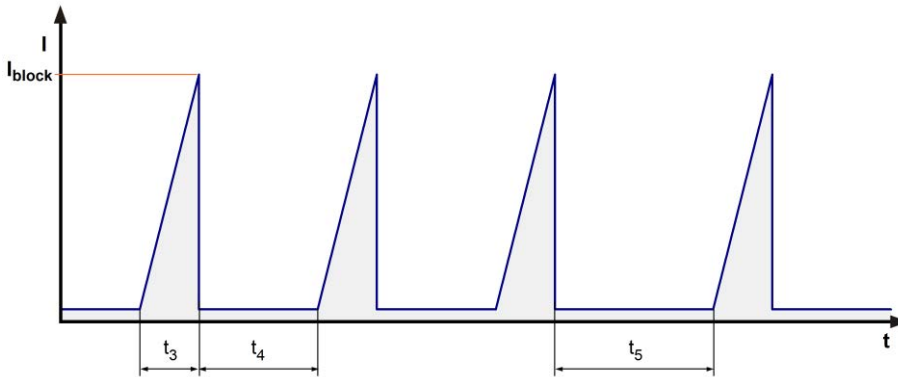

Locked rotor signal t_5 : 40.0 s

After 4 failed start-ups of t_3 to t_4 there is an extended timeout t_5 of 40s.

The first off-time t_4 is reduced to 3s.

3.5 Aerodynamics

Measurement conditions: Measured with a double chamber intake rig acc. to DIN EN ISO 5801. Normal air density = 1,2 kg/m³; Temperature 23°C +/- 3°C; In the intake and outlet area should not be any solid obstruction within 0,5 m. Motor shaft horizontal. The information is only valid under the specified test conditions and may be changed by the installation conditions. If there are deviations from the standard test conditions, the characteristic values must be checked under the installed conditions.

Measurement setup:	Measured between two steel plates
Steel plate:	140 mm x 140 mm
Intake nozzle:	D: 87 mm; R: 7 mm
Distance between bottom and top plate:	101 mm
Overlapping impeller / nozzle:	2 mm

a.) Operation condition:

5.000 1/min at free air flow	PWM 95 %; f: 2 kHz		
------------------------------	--------------------	--	--

Max. free-air flow ($\Delta p = 0 / \dot{V} = \text{max.}$)	460,0 m ³ /h	
Max. static pressure ($\Delta p = \text{max.} / \dot{V} = 0$)	535 Pa	

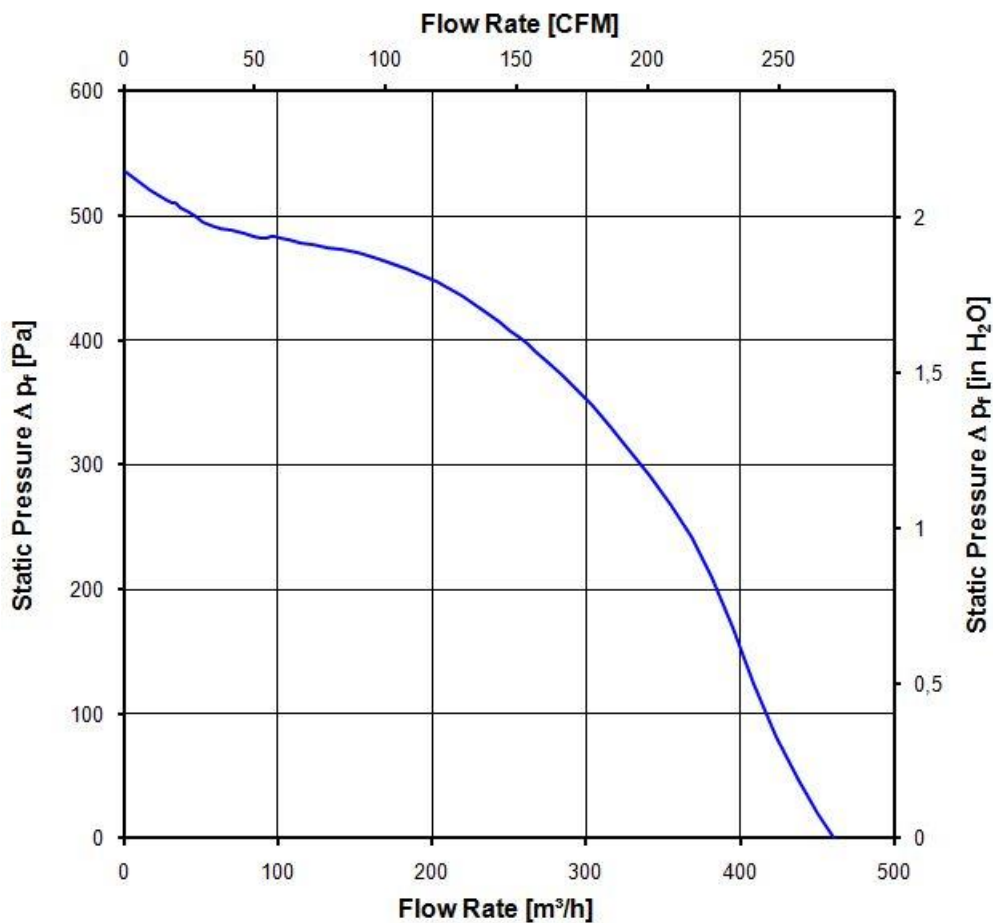

3.6 Sound Data

Measurement conditions: Sound pressure level: 1 meter distance between microphone and the air intake.
Sound power level: Acc. to DIN 45635 part 38 (ISO 10302)
Measured in a semianechoic chamber with a background noise level of $L_p(A) < 5 \text{ dB}(A)$
For further measurement conditions see chapter aerodynamics.

a.) Operation condition:

5.000 1/min at free air flow	PWM 95 %; f: 2 kHz		
------------------------------	--------------------	--	--

Optimal operating point	316,0 m ³ /h @ 290 Pa		
Sound power level at the optimal operating point	7,8 bel(A)		
Sound pressure level at free air flow, measured in rubber bands			

4 Environment

4.1 General

Min. permitted ambient temperature TU min.	-20 °C		
Max. permitted ambient temperature TU max.	65 °C		
Min. permitted storage temperature TL min.	-40 °C		
Max. permitted storage temperature TL max.	80 °C		

4.2 Climatic Requirements

Humidity requirements	humid heat, constant; according to DIN EN 60068-2-78, 14 days		
Water exposure	None		
Dust requirements	None		
Salt fog requirements	None		

Permitted application area:

The product is intended for use in sheltered rooms with controlled temperature and controlled humidity. Directly exposure to water must be avoided.

Pollution degree 1 (according DIN EN 60664-1)

There is either no pollution or it occurs only dry, non-conductive pollution. The pollution has no negative impact.

Please require severity levels and specification parameters from the responsible development departments.

5 Safety**5.1 Electrical Safety**

Dielectric strength DIN EN 62368 and DIN EN 60335 A.) Type test Measuring conditions: After 48h of storage at 95% R.H. and 25°C. No arcing or breakdown is allowed! All connections together to ground. B.) Routine test Measuring conditions: At indoor climate. No arcing or breakdown is allowed! All connections together to ground.	500 VAC / 1 Min. 850 VDC / 1 Sec.	
Isolation resistance Measuring conditions: After 48h of storage at 95% R.H. and 25°C measured with U=500 VDC for 1 min.	RI > 10 MOhm	
Clearance / creepage distance	1,0 mm / 1,2 mm	
Protection class	III	

5.2 Approval Tests

CE	EC Declaration of Conformity	Yes
EAC	Eurasian Conformity	Yes
UL	Underwriters Laboratories	Yes / UL507, Electric Fans E38324
VDE	Association for Electrical, Electronic and Information Technologies	Yes / Approval acc. to EN 62368 - Audio/video, information and communication technology equipment
CSA	Canadian Standards Association	Yes / C22.2 No. 113 Fans and Ventilators
CCC	China Compulsory Certification	Not applicable

The approval tests are observed to:

U approval max.:30,0 V @ TU approval max.: 65,0 °C

6 Reliability**6.1 General**

Life expectancy L10 at TU = 40 °C	72.500 h	
Life expectancy L10 at TU max.	40.000 h	
Life expectancy L10 acc. to IPC 9591 at TU = 40 °C	122.500 h	

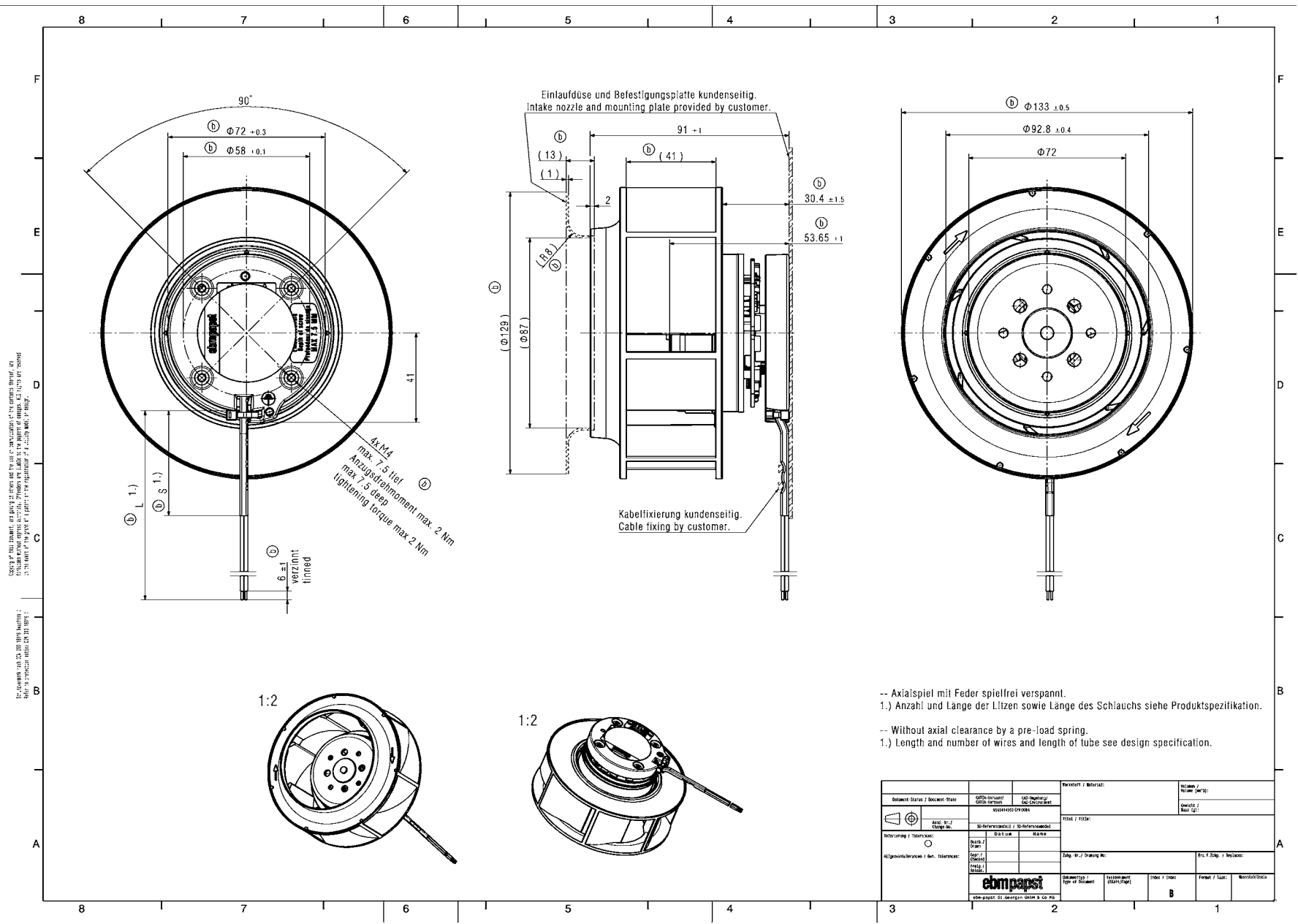

Copyright © 2014 ebmpapst. All rights reserved. The design of the ebmpapst logo and the design of the ebmpapst logo are trademarks of the ebmpapst group. All other trademarks are the property of their respective owners. All rights reserved.

-- Axialspiel mit Feder spielfrei verspannt.
1.) Anzahl und Länge der Litzen sowie Länge des Schlauchs siehe Produktspezifikation.

-- Without axial clearance by a pre-load spring.
1.) Length and number of wires and length of tube see design specification.

ebmpapst ebmpapst St. Georgen GmbH & Co. KG		ebmpapst ebmpapst St. Georgen GmbH & Co. KG		ebmpapst ebmpapst St. Georgen GmbH & Co. KG	
ebmpapst ebmpapst St. Georgen GmbH & Co. KG		ebmpapst ebmpapst St. Georgen GmbH & Co. KG		ebmpapst ebmpapst St. Georgen GmbH & Co. KG	
ebmpapst ebmpapst St. Georgen GmbH & Co. KG		ebmpapst ebmpapst St. Georgen GmbH & Co. KG		ebmpapst ebmpapst St. Georgen GmbH & Co. KG	
ebmpapst ebmpapst St. Georgen GmbH & Co. KG		ebmpapst ebmpapst St. Georgen GmbH & Co. KG		ebmpapst ebmpapst St. Georgen GmbH & Co. KG	
ebmpapst ebmpapst St. Georgen GmbH & Co. KG		ebmpapst ebmpapst St. Georgen GmbH & Co. KG		ebmpapst ebmpapst St. Georgen GmbH & Co. KG	