

QLN65/3000-3038

AC tangential blower

forward-curved

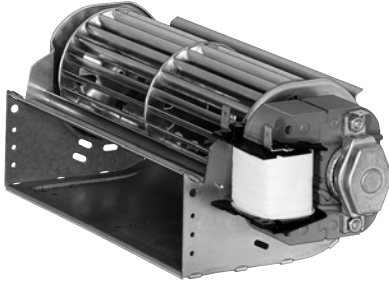

QLN65/3000-3038 ebmpapst Datasheet FansCo
sales@fansco.com
www.fansco.com

Nominal data

Type	QLN65/3000-3038	
Phase		1~
Nominal voltage	VAC	230
Frequency	Hz	50
Speed	min ⁻¹	1200
Power consumption	W	45
Current draw	A	0.415
Min. ambient temperature	°C	0
Max. ambient temperature	°C	60
Air flow	m ³ /h	250
Pressure increase	Pa	80

ml = Max. load · me = Max. efficiency · fa = Free air · cs = Customer specification · ce = Customer equipment
Subject to change



Technical description

Weight	1.75 kg
Dimensions	65 mm
Insulation class	B on request also F or H
Installation position	Horizontal or vertical with motor on bottom
Cable	Flat plug 6.3 x 0.8

Product drawing

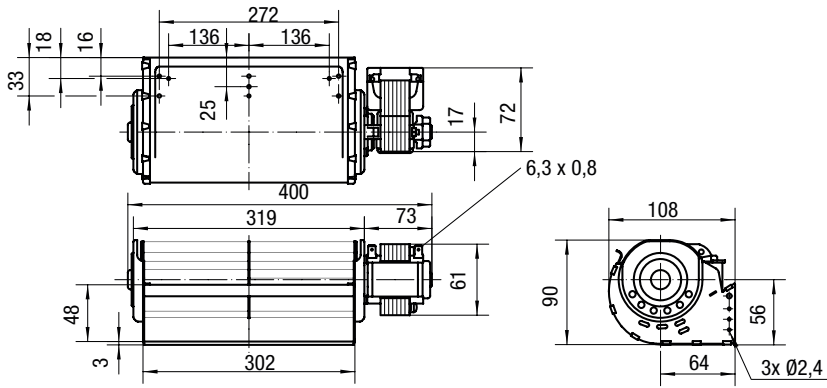

Curves: Air performance

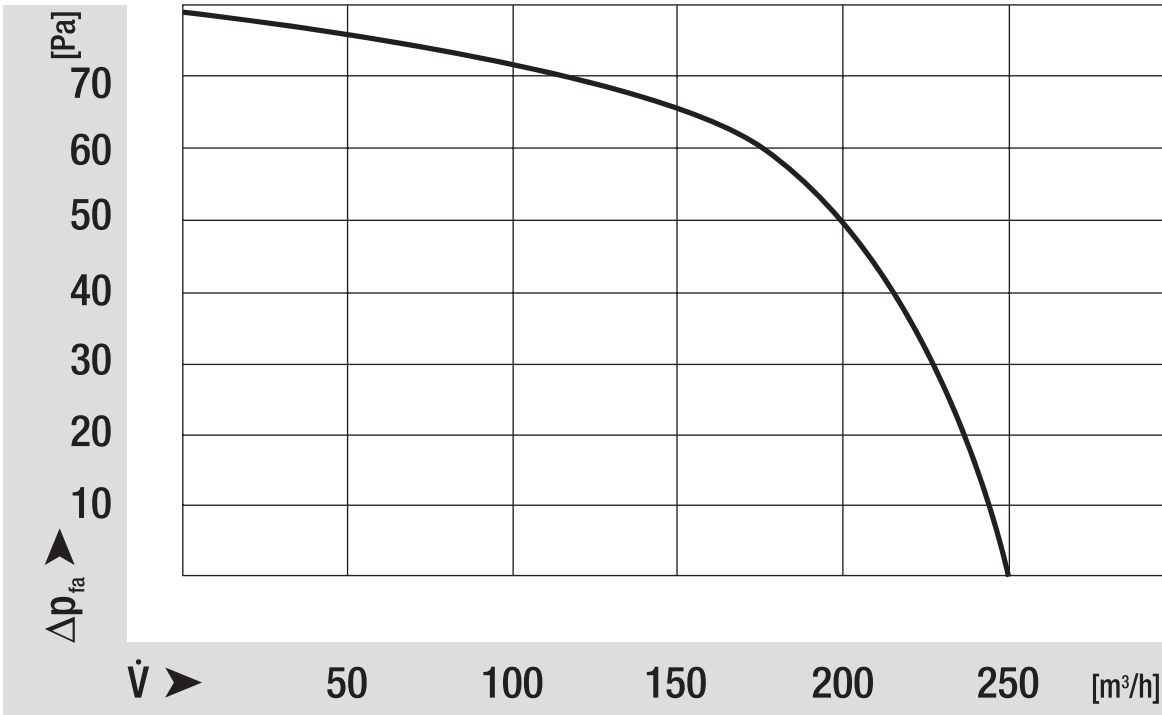

Curves: Speed

