

QG030-353/14

DC tangential blower

forward-curved



ebm-papst St. Georgen GmbH & Co. KG

Hermann-Papst-Str. 1

D-78112 St. Georgen

Phone +49 (0) 7724 81-0

Fax +49 (0) 7724 81-1309

sales@fansco.com

www.fansco.com

Nominal data

Type	QG030-353/14	
Nominal voltage	VDC	24
Nominal voltage range	VDC	16 .. 28
Power consumption	W	9.6
Min. ambient temperature	°C	-20
Max. ambient temperature	°C	60
Air flow	m ³ /h	155
Sound power level	B	5.9
Sound pressure level	dB(A)	51

ml = Max. load · me = Max. efficiency · fa = Free air · cs = Customer specification · ce = Customer equipment
Subject to change



Technical description

Weight	0.415 kg
Impeller material	Aluminum
Housing material	Aluminum, housing side parts made of plastic.
Direction of rotation	Clockwise, viewed toward rotor
Storage	Motor with ball bearing system. Impeller retaining plate with sleeve bearing.
Service life L10 at 40 °C	30000 h
Service life L10 at maximum temperature	20000 h
Cable	With leads AWG 24, TR 64
Motor protection	Protection against reverse polarity and blocked rotor.
Locked-rotor protection	Locked-rotor and overload protection
Approval	VDE, CSA, UL, CE



Product drawing

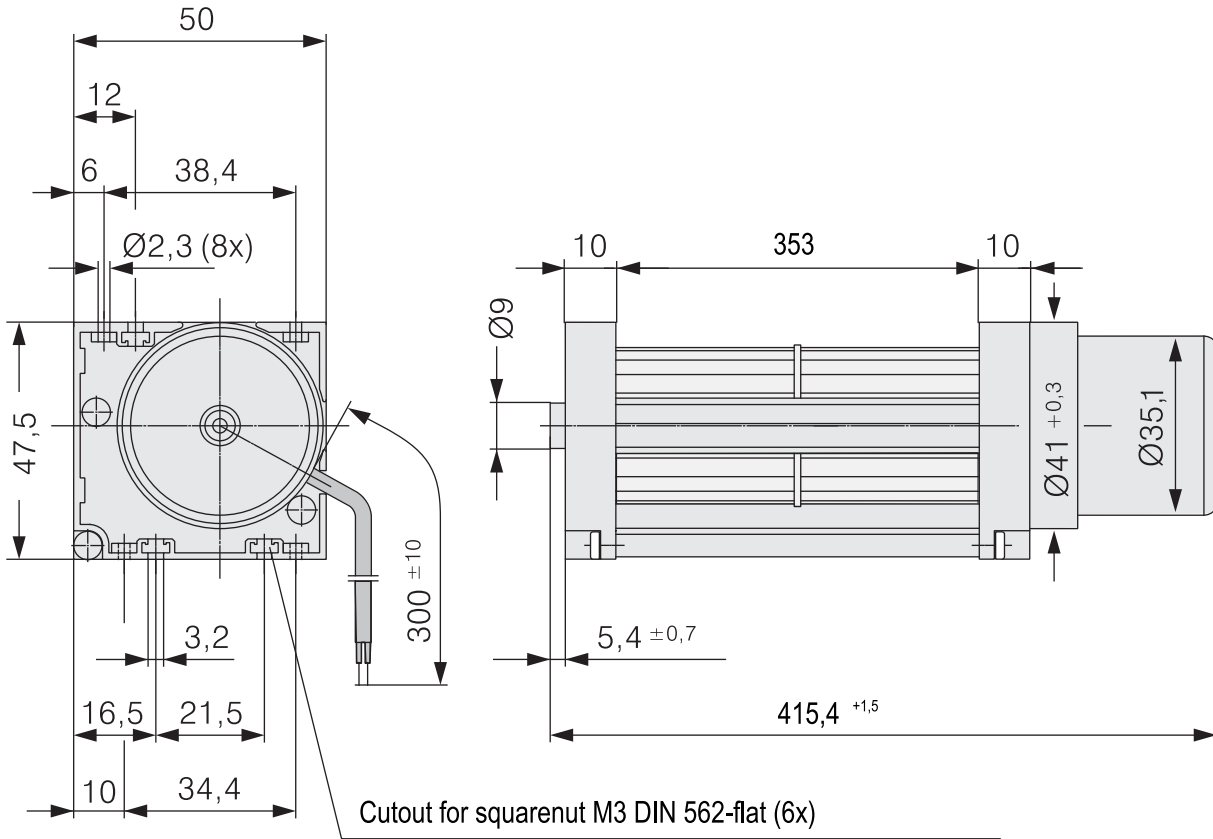

Curves

