

**Product Data Sheet**    **9204305012**  
VWC0119ASJAZ  
AC 4300/19H-012

**ebmpapst**

The engineer's choice

AC4300/19H-012 (9204305012) ebmpapst Datasheet  
sales@fansco.com  
www.fansco.com



AC 4300/19H-012

INDEX

**1 General ..... 3**

**2 Mechanics ..... 3**

2.1 General..... 3

2.2 Connections..... 3

**3 Operating Data ..... 4**

3.1 Electrical Interface - Input..... 4

3.2 Electrical Operating Data ..... 5

3.3 Electrical Interface - Output..... 5

3.4 Electrical Features ..... 7

3.5 Aerodynamics ..... 8

3.6 Sound Data..... 9

**4 Environment..... 10**

4.1 General..... 10

4.2 Climatic Requirements ..... 10

**5 Safety..... 11**

5.1 Electrical Safety ..... 11

5.2 Approval Tests..... 11

**6 Reliability..... 12**

6.1 General..... 12

**1 General**

Fan type	Fan
Rotating direction looking at rotor	Clockwise
Airflow direction	Air outlet over struts
Bearing system	Ball bearing
Mounting position - shaft	Any

**2 Mechanics****2.1 General**

Width	119,0 mm	
Height	119,0 mm	
Depth	32,0 mm	
Diameter	0,0 mm	
Mass	0,345 kg	
Housing material	Plastic	
Impeller material	Plastic	

**2.2 Connections**

Electrical connection	Wires	
Lead wire length	L = 450 mm	
Tolerance	+ - 10 mm	
Tube length	S = 15 mm	
Tolerance	+ - 5 mm	
Wire size (AWG)		
Insulation diameter	1,10 mm	
Plug	See drawing	
Contact	See drawing	

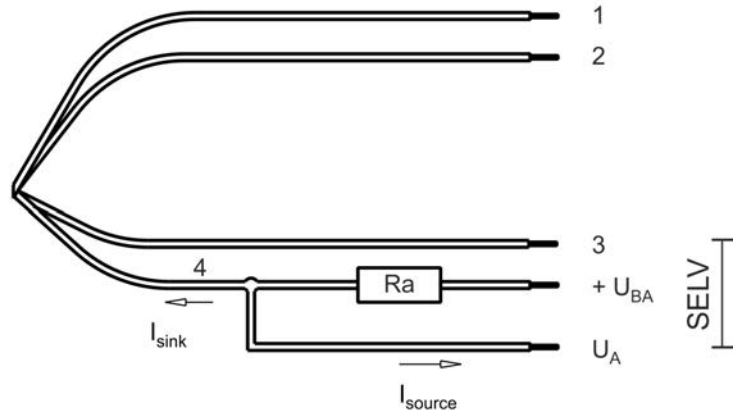

Wire	Color	Operation
1	black	L1
2	black	L2
3	blue	- GND Alarm
4	white	Alarm

### 3 Operating Data

#### 3.1 Electrical Interface - Input

External voltage supply for input and output signals must be SELV conform.

Control input	None
---------------	------

#### Features

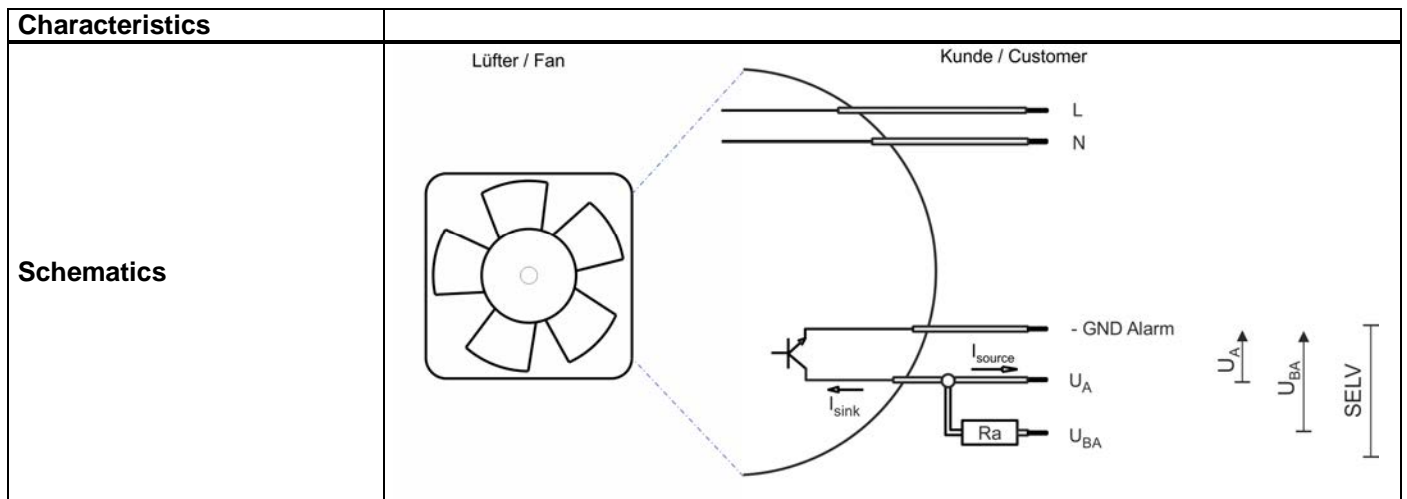

## 3.2 Electrical Operating Data

Features	Condition	Symbol	Values			
Voltage range Tolerance		U	85 V			265 V
Nominal voltage		$U_N$		115 V	230 V	
Frequency		f	50 Hz / 60 Hz			
Power consumption Tolerance	$\Delta p = 0$	P	11 W +/- 30 %			
Current consumption Tolerance	$\Delta p = 0$	$I_{RMS}$	200 mA +/- 30 %	165 mA +/- 35 %	80 mA +/- 30 %	70 mA +/- 35 %
Speed Tolerance	$\Delta p = 0$	n	3.400 1/min +/- 5 %			

## 3.3 Electrical Interface - Output

External voltage supply for input and output signals must be SELV conform.
--

Alarm type	/19 (low = ok, open collector inverse)
------------	--

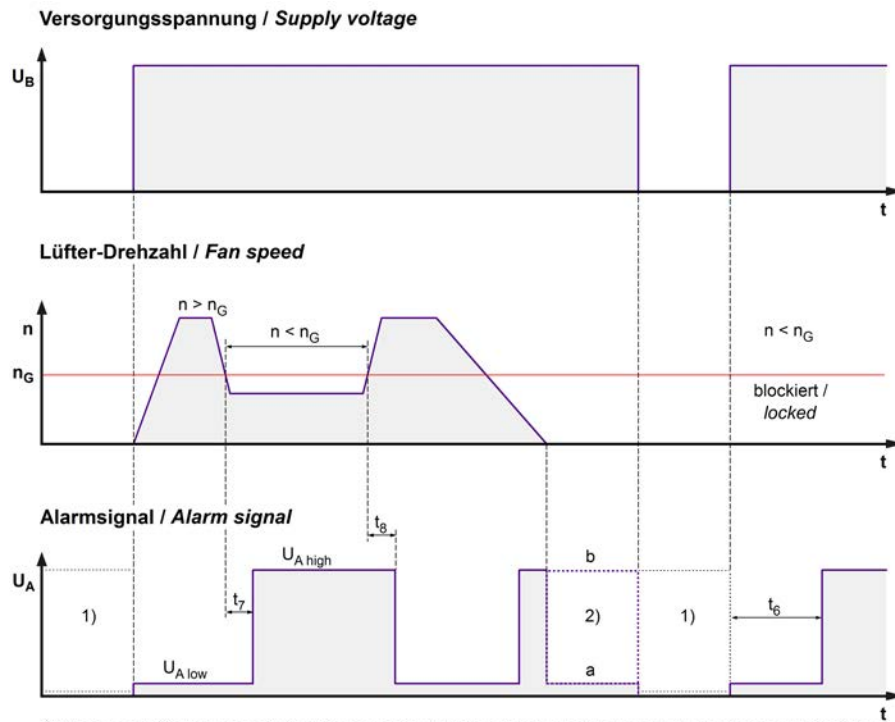

$$R_a = \frac{U_{BA} - U_{A\text{low}}}{I_{\text{sink}}}$$

Lüfter / Fan      Kunde / Customer

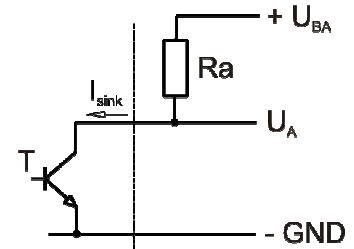

- 1) Wenn der Lüfter abgeschaltet ist, hängt der Zustand des Ausgangssignals  $U_A$  von der Kundenapplikation ab.  
*When the fan is powered off, the output signal  $U_A$  depends on the customer's application.*
- 2) Für den gültigen Zustand (a oder b) siehe Alarmunterdrückung in der Tabelle.  
*For the valid condition (a or b) see alarm suppression in the table.*

Features	Note	Values
Alarm operating voltage		$\leq 48 \text{ V}$
Alarm signal Low	$I_{\text{sink}}: 2 \text{ mA}$	$< 0,4 \text{ V}$
Alarm signal High	$I_{\text{source}}: 0 \text{ mA}$	$\leq 48 \text{ V}$
Maximum sink current		$\leq 20 \text{ mA}$
External resistor	External resistor $R_a$ from $U_{BA}$ to $U_A$ required. All voltage measured to GND.	
Alarm trip speed limit Tolerance		1.500 1/min +/- 100 1/min
Alarm at sense failure	No	
Alarm latch	No	
Alarm isolated from motor	No	

3.4 Electrical Features

Electronic function	Speed-Controlled	
Locked rotor protection	Auto restart	
Clock signal at locked rotor	$t_3/t_4$ typical: 0,6 s / 20 s	

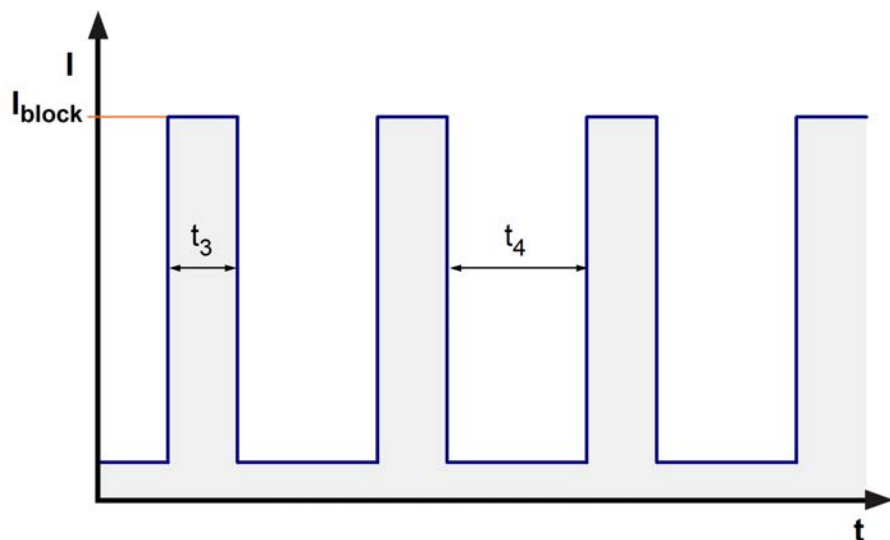

**3.5 Aerodynamics**

Measurement conditions: Measured with a double chamber intake rig acc. to DIN EN ISO 5801.  
 Normal air density = 1,2 kg/m<sup>3</sup>; Temperature 23°C +/- 3°C;  
 In the intake and outlet area should not be any solid obstruction within 0,5 m. Motor shaft horizontal.  
 The information is only valid under the specified test conditions and may be changed by the installation conditions. If there are deviations from the standard test conditions, the characteristic values must be checked under the installed conditions.

a) Operation condition:  
 3.400 1/min at free air flow                      Frequency: 50 Hz                      Nominal voltage: 230 V

Max. free-air flow ( $\Delta p = 0 / \dot{v} = \text{max.}$ )	204,0 m <sup>3</sup> /h
Max. static pressure ( $\Delta p = \text{max.} / \dot{v} = 0$ )	85 Pa

b) Operation condition:  
 3.400 1/min at free air flow                      Frequency: 60 Hz                      Nominal voltage: 115 V

Max. free-air flow ( $\Delta p = 0 / \dot{v} = \text{max.}$ )	204 m <sup>3</sup> /h
Max. static pressure ( $\Delta p = \text{max.} / \dot{v} = 0$ )	85 Pa

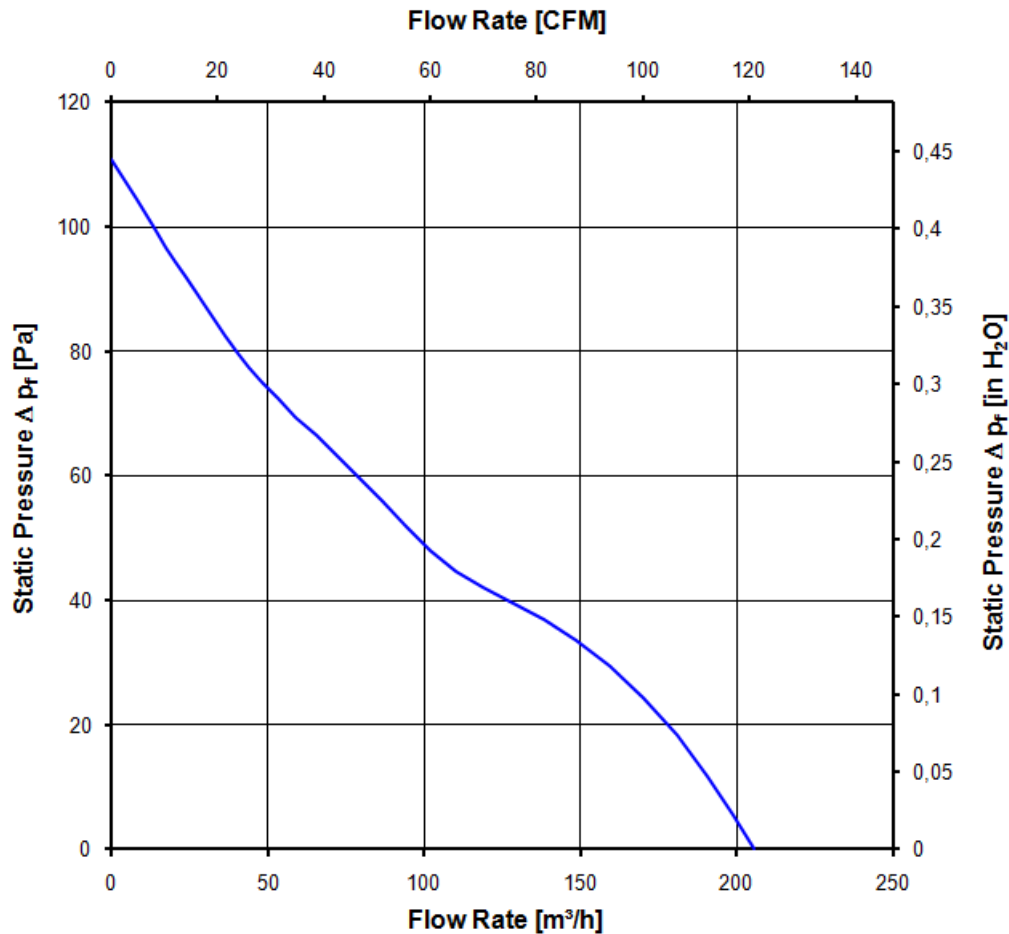

### 3.6 Sound Data

Measurement conditions: Sound pressure level: 1 meter distance between microphone and the air intake.  
Sound power level: Acc. to DIN 45635 part 38 (ISO 10302)  
Measured in a semianchoic chamber with a background noise level of  $L_p(A) < 5 \text{ dB}(A)$   
For further measurement conditions see chapter aerodynamics.

## a) Operation condition:

3.400 1/min at free air flow

Frequency: 50 Hz

Nominal voltage: 230 V

Optimal operating point	155,0 m <sup>3</sup> /h @ 28 Pa	
Sound power level at the optimal operating point	6,4 bel(A)	
Sound pressure level at free air flow, measured in rubber bands	52,0 dB(A)	

## b) Operation condition:

3.400 1/min at free air flow

Frequency: 60 Hz

Nominal voltage: 115 V

Optimal operating point	155,0 m <sup>3</sup> /h @ 28 Pa	
Sound power level at the optimal operating point	6,4 bel(A)	
Sound pressure level at free air flow, measured in rubber bands	52,0 dB(A)	

## 4 Environment

### 4.1 General

Min. permitted ambient temperature TU min.	-20 °C	
Max. permitted ambient temperature TU max.	70 °C	
Min. permitted storage temperature TL min.	-40 °C	
Max. permitted storage temperature TL max.	80 °C	

### 4.2 Climatic Requirements

IP-protection type (certified)	IP 20 **)	
Humidity requirements	humid heat, constant; according to DIN EN 60068-2-78, 14 days	
Salt fog requirements	None	

Permitted application area:

The product is intended for use in sheltered rooms with controlled temperature and controlled humidity. Directly exposure to water must be avoided.

Pollution degree 1 (according DIN EN 60664-1)

There is either no pollution or it occurs only dry, non-conductive pollution. The pollution has no negative impact.

\*\*) The specification of the IP protection refers to the conditions mentioned in certification of the fan. The above mentioned short description of the protection scope is not final. For detailed information of the respective protection scope and definitions, see certification as well as DIN EN 60529 (protection by housings) and ISO 20653 (for vehicles) with the letter K.

#### **Short description of the IP-protection type:**

Solid particle Protection: Protected against solid particles with a diameter of 12.5 mm and larger.

Protection against deliberate contact: Protected against contact to hazardous parts with a finger.

Protection against water: No protection.

## 5 Safety

### 5.1 Electrical Safety

A verification of thermal conditions (normal and abnormal operation) as well as the protection against electric shock, ingress of solid foreign objects and water has to be done in conjunction with the appliance.

Test voltage HV type test	1500 V
Unit test voltage	VAC
Time type test HV	1 s
Insulation resistance	RI > 10 MOhm
Protection class	built-in fan

### 5.2 Approval Tests

CE	EC Declaration of Conformity	Yes
EAC	Eurasian Conformity	Yes
UL	Underwriters Laboratories	Yes / UL507, Electric Fans E38324
VDE	Association for Electrical, Electronic and Information Technologies	Yes / Approval acc. to EN 60335 (VDE 0700) - Safety for household and similar electrical appliances
CSA	Canadian Standards Association	Yes
CCC	China Compulsory Certification	Yes / GB 12350 Safety Requirements for small Power Motors

According to the guidelines on the application of Directive 2006/95/EC, chapter III: Scope of the "low voltage" directive, paragraph: Are "components" included in the scope? the following has to be applied:

However, some types of electrical devices, designed and manufactured for being uses as basic components to be incorporated into other electrical equipment, are such that their safety to a very large extent depends on how they are integrated into the final product and the overall characteristics of the final product. These basic components include electronic and certain other components.

Taking into account these objectives of the "Low Voltage" Directive, such basic components, the safety of which can only, to a very large extend, be assessed taking into account, how they are incorporated and for which a risk assessment cannot be undertaken, then they are not covered as such by the Directive. In particular, they must not be CE marked unless covered by other Community legislation that requires CE marking.

**6 Reliability****6.1 General**

Life expectancy L10 at TU = 40 °C	45.000 h	
Life expectancy L10 at TU max.	22.500 h	
Life expectancy L10 acc. to IPC 9591 at TU = 40 °C	75.0 00 h	

Copyright of this document, and given in to others and the use or communication of the contents thereof, are reserved in the event of the grant of patent or the registration of a utility model or design.  
 Infringement with respect to any of the rights reserved in this document shall be liable to the payment of damages. All rights are reserved.  
 Schutzrechte nach DIN ISO 9015 behält  
 Refer to protection notice DIN ISO 9015 below

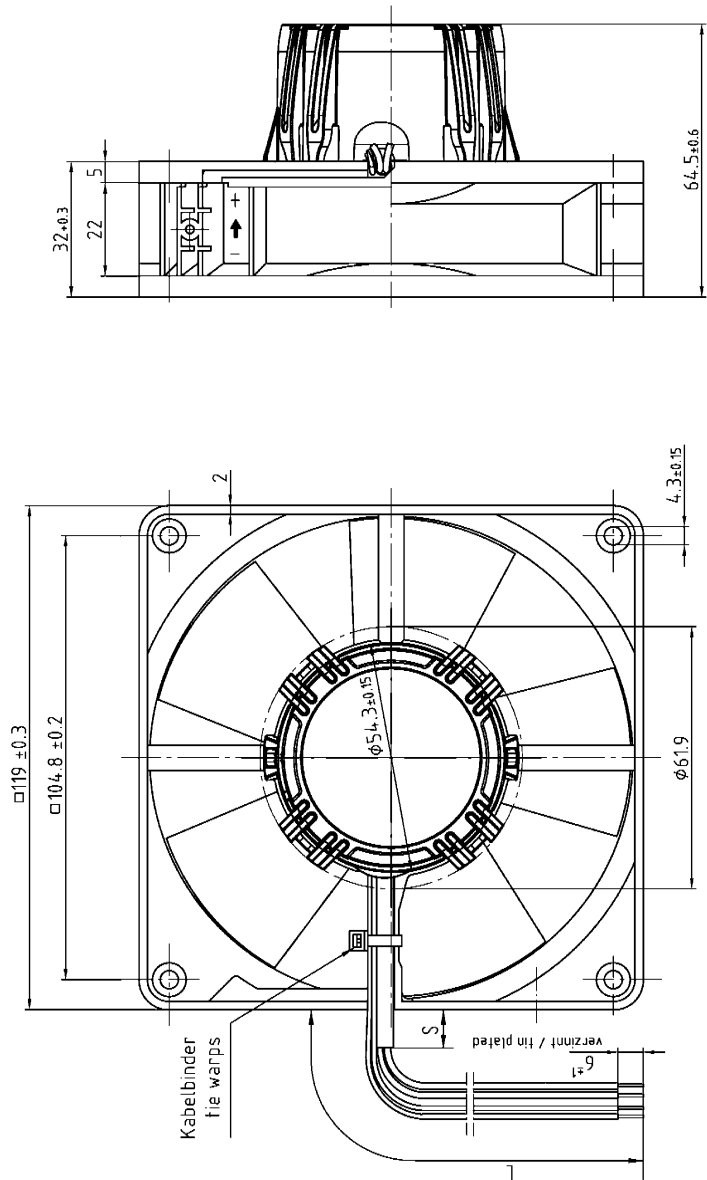

Anzahl und Länge der Litzen (L) sowie Schlauchlänge (S) siehe Produkt spezifikation  
 length (L) and number of wires and length (S) of tube see design specification

Axialspiel bei - Kugellagerung: 0 (Federverspannung)  
 - Gleitlagerung (G): 0.1 - 0.5mm  
 axial clearance by - ball bearings: 0 (spring-tension)  
 - floating bearings (G): 0.1 - 0.5mm

Teilenummer/Part number: DIN 7167		Art./Item/ Title		Massstab/Scale	
Allgemeintoleranzen/ Gen. tolerances: DIN ISO 2768-mK-E		AC maxx axial fan		Blatt/Page	
Bezeichnung/Designation	Name/Name	<b>ebmpapst</b>		Ers./Replaces: Ers./Replaces:	
Hersteller/Manufacturer	Name/Name				
Material/Date	Name/Name	7thg. Nr. / Draw. No.		Blatt/Page	
Verwendungszweck/Use	Name/Name	ehp-papst-St. Georgen GmbH & Co. KG		A3	