

A1G300-AC33-52 ebmpapst Datasheet

sales@fansco.com

www.fansco.com

Limited partnership · Headquarters Muldingen

Amtsgericht (court of registration) Stuttgart · HRA 590344

General partner Elektrobau Muldingen GmbH · Headquarters Muldingen

Amtsgericht (court of registration) Stuttgart · HRB 590142

## Nominal data

Type	A1G300-AC33-52	
Motor	M1G074-CF	
Nominal voltage	VDC	48
Nominal voltage range	VDC	36 .. 57
Method of obtaining data		fa
Speed (rpm)	min <sup>-1</sup>	1830
Power consumption	W	80
Current draw	A	1.9
Max. back pressure	Pa	100
Max. back pressure	in. wg	0.4
Min. ambient temperature	°C	-25
Max. ambient temperature	°C	60

ml = Max. load · me = Max. efficiency · fa = Free air · cs = Customer specification · ce = Customer equipment  
Subject to change



### Technical description

<b>Weight</b>	1.8 kg
<b>Size</b>	300 mm
<b>Motor size</b>	74
<b>Rotor surface</b>	Painted black
<b>Blade material</b>	Press-fitted sheet steel blank, sprayed with PP plastic
<b>Number of blades</b>	5
<b>Airflow direction</b>	A
<b>Direction of rotation</b>	Clockwise, viewed toward rotor
<b>Degree of protection</b>	IP42
<b>Insulation class</b>	"B"
<b>Moisture (F) / Environmental (H) protection class</b>	F0; H0 - dry environment
<b>Max. permitted ambient temp. for motor (transport/storage)</b>	+ 80 °C
<b>Min. permitted ambient temp. for motor (transport/storage)</b>	- 40 °C
<b>Installation position</b>	Any
<b>Condensation drainage holes</b>	None
<b>Mode</b>	S1
<b>Motor bearing</b>	Ball bearing
<b>Technical features</b>	<ul style="list-style-type: none"> <li>- Tach output</li> <li>- Motor current limitation</li> <li>- Soft start</li> <li>- Control input 0-10 VDC / PWM</li> </ul>
<b>EMC immunity to interference</b>	According to EN 61000-6-2 (industrial environment)
<b>EMC interference emission</b>	According to EN 55022 (Class B)
<b>Motor protection</b>	Reverse polarity and locked-rotor protection
<b>With cable</b>	Variable
<b>Conformity with standards</b>	EN 60950-1
<b>Approval</b>	EAC; UL 1004-1; CSA C22.2 No. 77

Product drawing

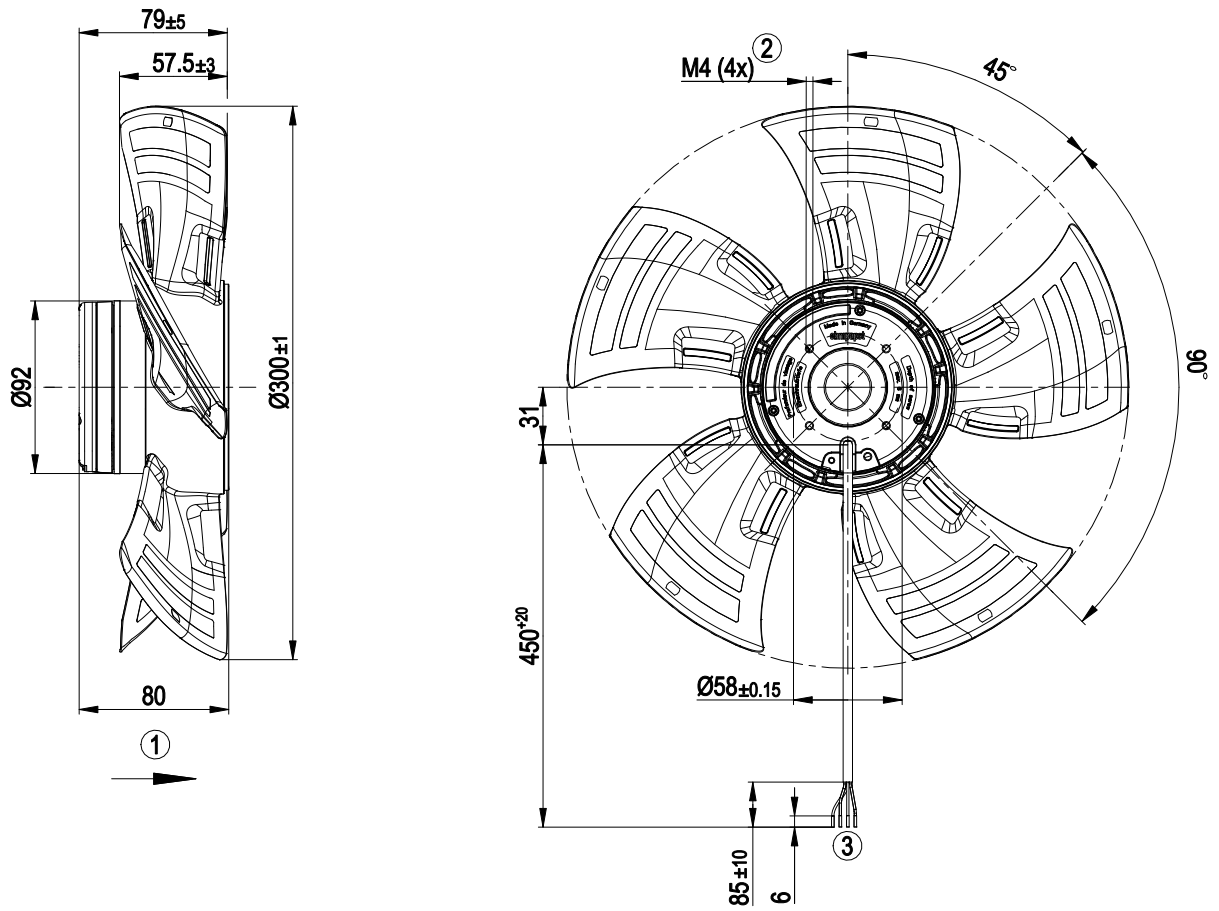

1	Direction of air flow "A"
2	Max. clearance for screw 6 mm
3	Cable PVC AWG20, 4x crimped splices



## Connection diagram

### Customer circuit

Full speed

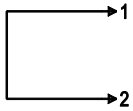

Adjustable speed

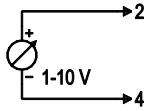

10 V → n = max  
 1 V → n = min  
 < 1 V → n = 0  
 Safe start at Unom -30% from 4 V Ucontr.

Speed adjustable via potentiometer

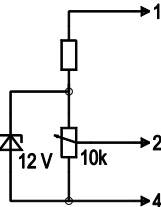

Speed adjustable via PWM 1-10 kHz

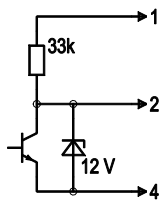

100% PWM → n = max  
 10% PWM → n = min  
 < 10% PWM → n = 0  
 Safe start at Unom -30% from 40% PWM

Set value requirement via ebrm-papst temperature controller

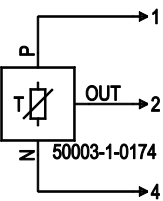

T < 10 °C → n = 0  
 T > 45 °C → n = max

### Connection

### Fan / Motor

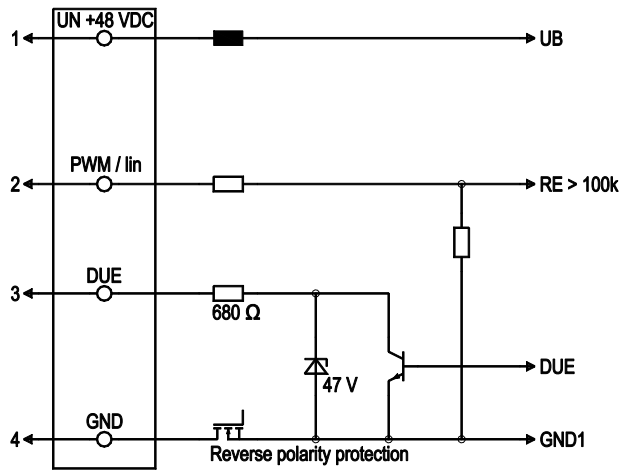

No.	Conn.	Designation	Color	Function/assignment
1	1	Un +48 VDC	red	Power supply 48 VDC, maximum ripple 3.5%
1	2	PWM / lin	yellow	PWM / lin. Control input 0-10 V
1	3	Tach	white	Tach output, 3 pulses per revolution, Isink max = 10 mA
1	4	GND	blue	Reference ground



## Curves: Air performance

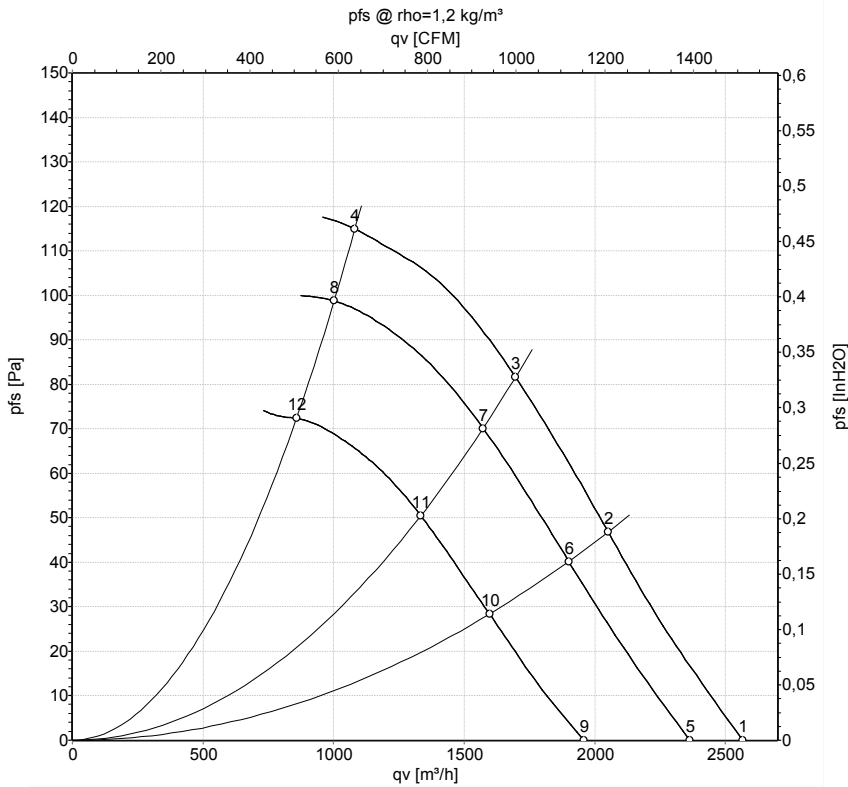

Measurement: LU-137645-1  
 Measurement: LU-137650-1  
 Measurement: LU-137644-1

Air performance measured according to ISO 5801 installation category A. For detailed information on the measurement setup, contact ebmpapst. Intake sound level: Sound power level according to ISO 13347 / sound pressure level measured at 1 m distance from fan axis. The values given are valid under the specified measuring conditions and may vary due to conditions of installation. For deviations from the standard configuration, the parameters have to be checked on the installed unit.

## Measured values

	U	n	P <sub>ed</sub>	I	LpA <sub>in</sub>	LwA <sub>in</sub>	q <sub>v</sub>	P <sub>fs</sub>	q <sub>v</sub>	P <sub>fs</sub>
	V	min <sup>-1</sup>	W	A	dB(A)	dB(A)	m <sup>3</sup> /h	Pa	cfm	in. wg
1	57	1985	103	2.05	62	69	2565	0	1510	0.00
2	57	1875	105	2.14	61	69	2050	47	1210	0.19
3	57	1820	107	2.20	60	68	1695	82	1000	0.33
4	57	1720	111	2.32	66	74	1080	115	635	0.46
5	48	1830	80	1.90	60	67	2365	0	1390	0.00
6	48	1735	84	1.97	60	68	1900	40	1120	0.16
7	48	1690	85	2.01	59	66	1575	70	925	0.28
8	48	1595	88	2.10	64	72	1000	100	590	0.40
9	36	1515	46	1.44	55	62	1960	0	1155	0.00
10	36	1455	50	1.56	55	63	1600	28	940	0.11
11	36	1430	52	1.62	54	62	1335	51	785	0.20
12	36	1375	56	1.74	59	67	860	72	505	0.29

U = Voltage · n = Speed (rpm) · P<sub>ed</sub> = Power consumption · I = Current draw · LpA<sub>in</sub> = Sound pressure level intake side · LwA<sub>in</sub> = Sound power level intake side · q<sub>v</sub> = Air flow  
 P<sub>fs</sub> = Pressure increase

