

Product Data Sheet

9295420500

VUC0140AULDS

5318/2TDH4P

ebmpapst

The engineer's choice

5318/2TDH4P (9295420500) ebmpapst Datasheet

sales@fansco.com

www.fansco.com



5318/2TDH4P (9295420500) ebmpapst Datasheet sales@fansco.com www.fansco.com



5318/2TDH4P

INDEX

1 General 3

2 Mechanics 3

2.1 General..... 3

2.2 Connections..... 3

3 Operating Data 4

3.1 Electrical Interface - Input..... 4

3.2 Electrical Operating Data 5

3.3 Electrical Interface - Output..... 6

3.4 Electrical Features 7

3.5 Data According ErP Directive 7

3.6 Aerodynamics 8

3.7 Sound Data..... 9

4 Environment..... 9

4.1 General..... 9

4.2 Climatic Requirements 9

5 Safety..... 10

5.1 Electrical Safety 10

5.2 Approval Tests 10

6 Reliability..... 10

6.1 General..... 10

1 General

Fan type	Fan	
Rotating direction looking at rotor	Counterclockwise	
Airflow direction	Air intake over struts	
Bearing system	Ball bearing	
Mounting position - shaft	Any	

2 Mechanics

2.1 General

Width	140,0 mm	
Height	140,0 mm	
Depth	51,0 mm	
Mass	0,930 kg	
Housing material	Metal	
Impeller material	Plastic	
Max. torque when mounted across both mounting flanges	Wire outlet corner: 440 Ncm Remaining corners: 600 Ncm	
Screw size	ISO 4762 - M4 degreased, without an additional brace and without washer	

2.2 Connections

Electrical connection	Wires	
Lead wire length	L = 310 mm	
Tolerance	+ - 10,0 mm	

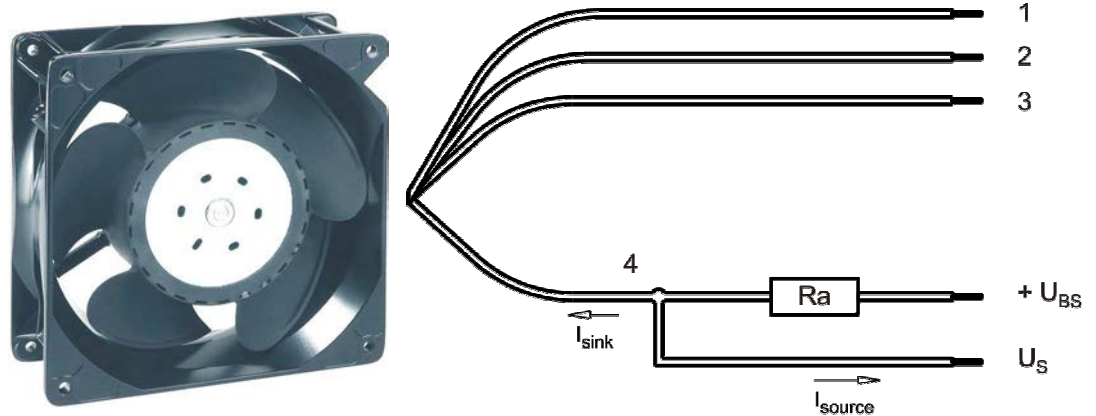

Wire	Color	Operation	Wire size	Insulation diameter
1	red	+ UB	AWG 20	2,05 mm
2	blue	- GND	AWG 20	2,05 mm
3	violet	PWM	AWG 22	1,3 mm
4	white	Tacho	AWG 22	1,3 mm

The auxiliaries shown on the schematic diagram (which are required for the intended use) are not part of our delivery.

3 Operating Data

3.1 Electrical Interface - Input

Control input	PWM
---------------	-----

Features

Input type	Open collector	
PWM - Frequency		typical: 2 kHz
Input frequency range		1 kHz - 10 kHz

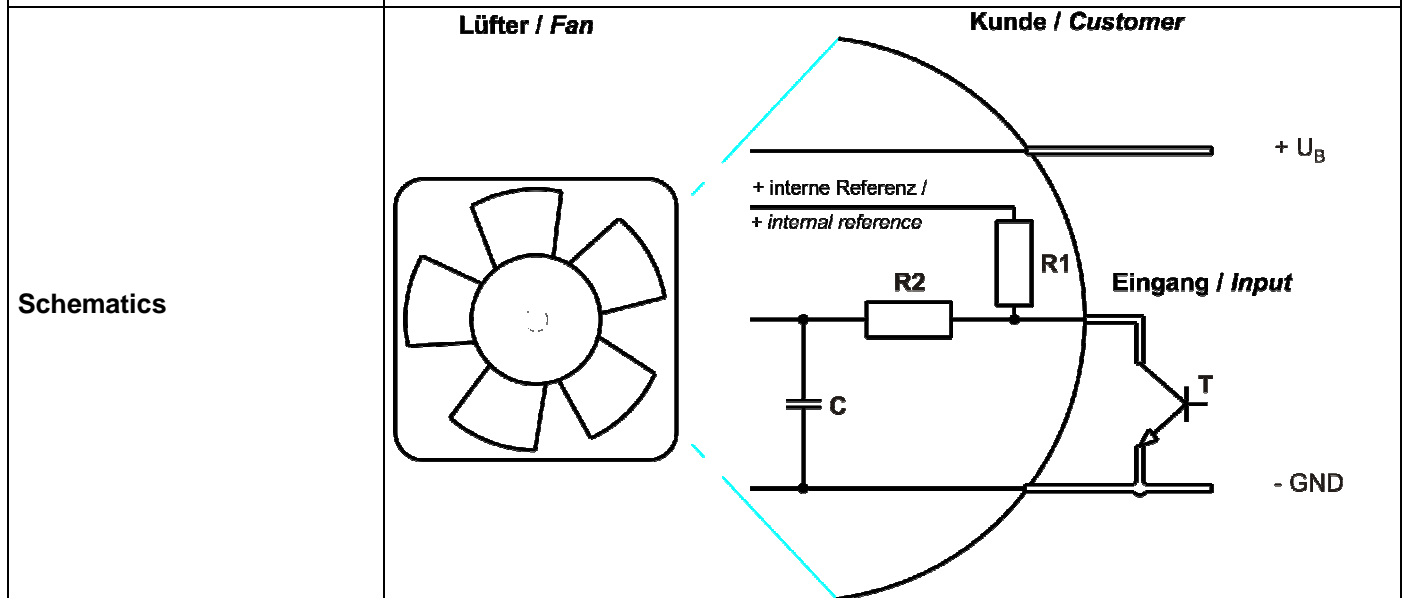
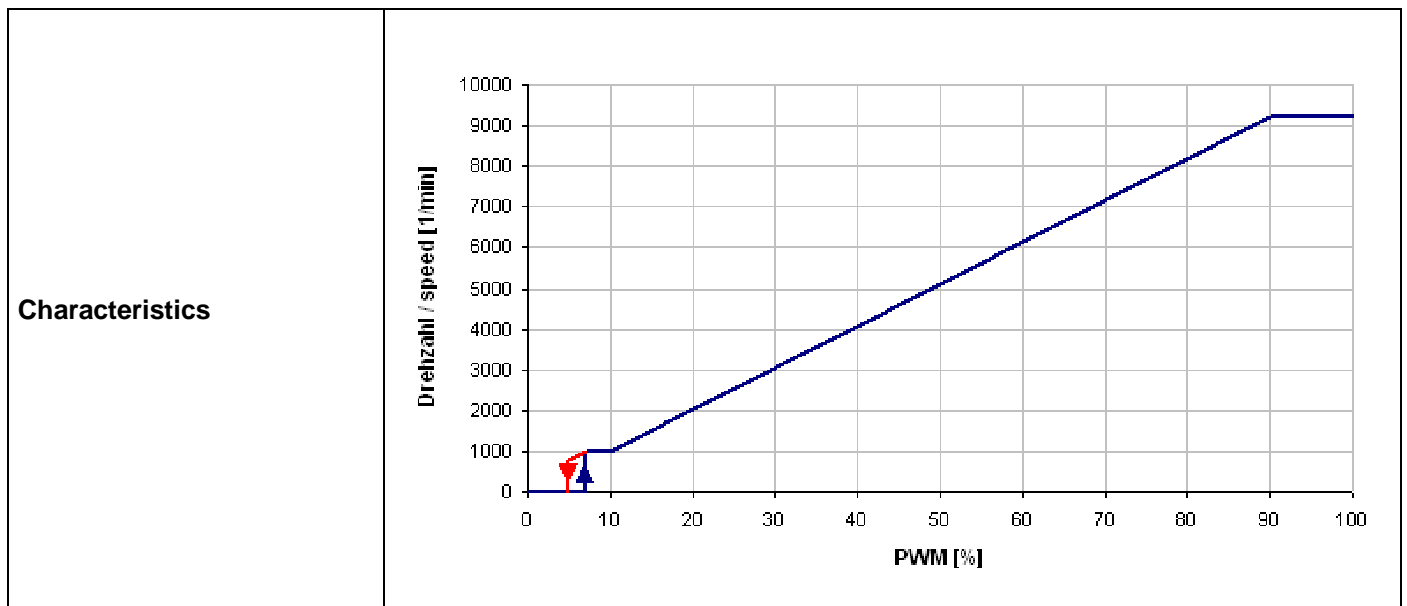

The shown pull-up resistor R1 to the internal reference voltage (+5V) has 4.7kOhm.

Speed control:

By pulse width modulation (PWM) 0...100%

Open collector in relation to signal-ground.

Transistor requirements:

V_{ce} max. >= 12V; I_{sink} max. >=5mA; V_{ce} sat. <= 0,15V

Information to the curve:

0 % - 7% PWM: 0 1/min
 7 % PWM: 1.000 1/min (Fan on, comming from 0% PWM)
 7 % - 10% PWM: 1.000 1/min (corresponding to min. speed)
 10 % - 90% PWM: linear increasing curve
 90 % - 100% PWM: 6.000 1/min (corresponding to max. speed)
 7 % - 5 % PWM: linear decreasing curve (comming from 100% PWM)
 5 % PWM: 800 1/min or 0 1/min (Fan off, comming from 100% PWM)

3.2 Electrical Operating Data

Measurement conditions: Normal air density = 1,2 kg/m³; Temperature 23°C +/- 3°C; Motor axis horizontal; warm-up time before measuring 5 minutes (unless otherwise specified). In the intake and outlet area should not be any solid obstruction within 0,5 m.

$\Delta p = 0$: corresp. to free air flow (see chapter aerodynamics)
 I: corresp. to arithm. mean current value

Name	Condition
PWM 0001	PWM: 100 %; f: 2 kHz

100% PWM or broken lead wire (open control input)

Features	Condition	Symbol	Values		
Voltage range		U	36 V		72 V
Nominal voltage		U _N		48 V	
Power consumption	$\Delta p = 0$	P		144 W	162 W
Tolerance	PWM 0010			+/- 10 %	
Current consumption	$\Delta p = 0$	I		3.000 mA	
Tolerance	PWM 0010			+/- 10 %	
Speed	$\Delta p = 0$	n	9.000 1/min	9.200 1/min	9.200 1/min
Tolerance	PWM 0010		+/- 10 %	+/- 5 %	+/- 5 %

3.3 Electrical Interface - Output

Tacho type	/2 (open collector)
------------	---------------------

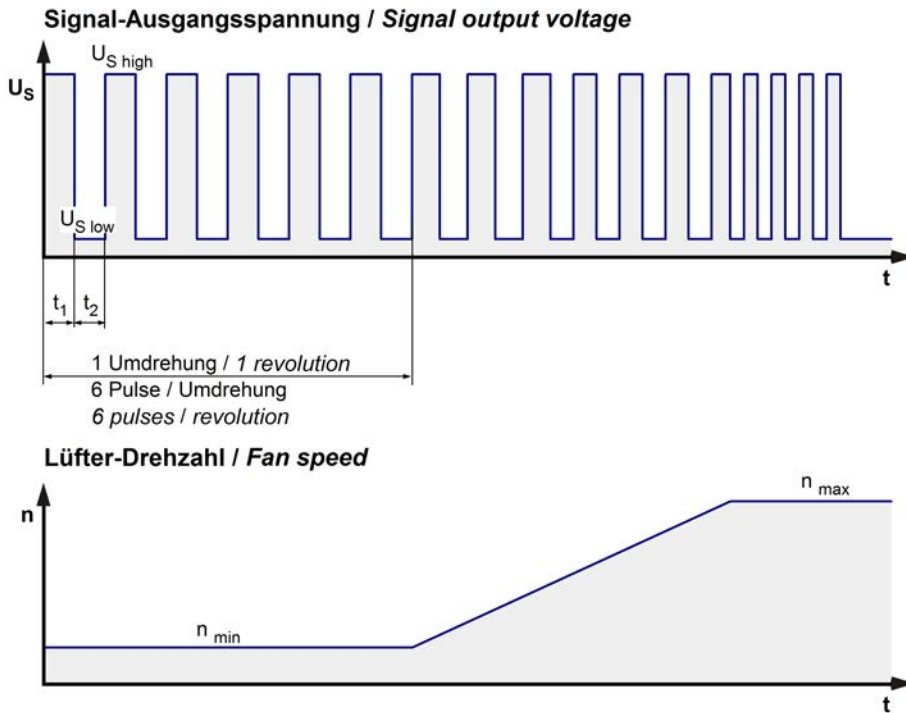

$$R_a = \frac{U_{BS} - U_{S\ low}}{I_{sink}}$$

Lüfter / Fan Kunde / Customer

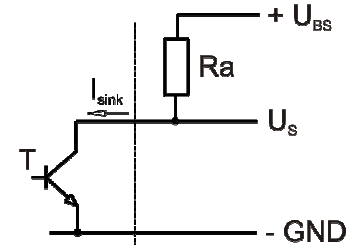

Features	Note	Values
Tacho operating voltage	U_{BS}	$\leq 60\ V$
Tacho signal Low	$U_{S\ low}$	$\leq 0,4\ V$
Tacho signal High	$U_{S\ high}$	$\leq 60\ V$
Maximum sink current	I_{sink}	$\leq 20\ mA$
External resistor	External resistor R_a from U_{BS} to U_s required. All voltages measured to GND.	
Tacho frequency	$(6 \times n) / 60$	920 Hz @ 9.200 1/min
Tacho isolated from motor	No	
Slew rate		$\Rightarrow 0,5\ V/\mu s$

n = revolutions per minute (1/min)

3.4 Electrical Features

Electronic function	Speed-Controlled	
Reversed polarity protection	P-CH FET	
Max. residual current at U_N	$I_F \leq 5 \text{ mA}$	
Locked rotor protection	Auto restart	
Locked rotor current at U_N	I_{block}	
Clock signal at locked rotor	t_3 / t_4 typical: 1,0 s / 10,0 s	
Internal fuse	Littelfuse NANO2 > Very Fast-Acting > 451/453 Series 10A / 125V (Art.No.: 0451010.MRL)	
Voltage control *)	Fan turns on at $U_B > 34 \text{ V}$ or $< 78 \text{ V}$ Fan turns off at $U_B < 32 \text{ V}$ or $> 78 \text{ V}$	

*) This fan has an undervoltage and overvoltage control circuit integrated which turns the motor off if the voltage is out of range.

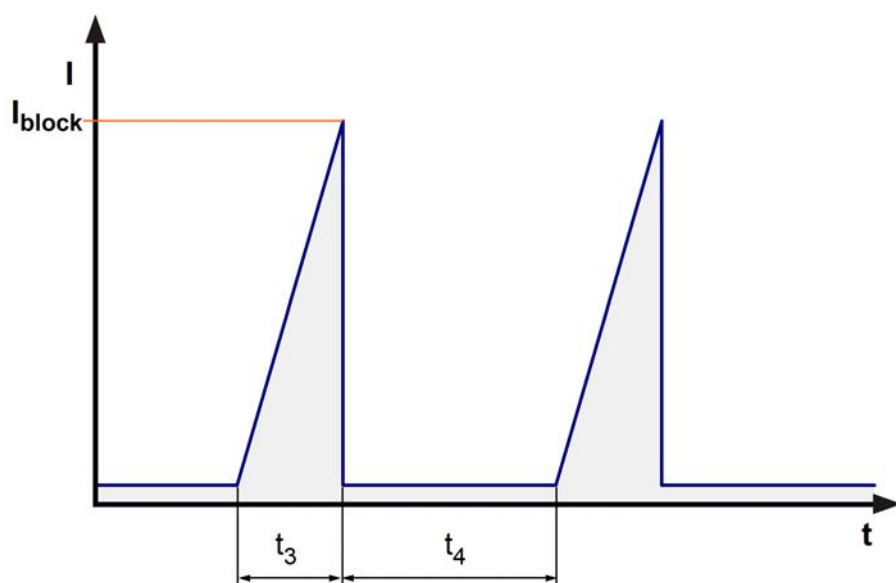

3.5 Data According ErP Directive

Installation / Efficiency category	A / static
Speed control	integrated
Specific ratio	1,00608
Target overall efficiency 2015	29,3 %
Overall efficiency	39,8 %
Efficiency grade	40
Power input	200 W
Speed	9.275 1/min

All values measured in optimum energy efficiency point.

Productiondatecode is printed on the fan label.

3.6 Aerodynamics

Measurement conditions: Measured with a double chamber intake rig acc. to DIN EN ISO 5801.
Normal air density = 1,2 kg/m³; Temperature 23°C +/- 3°C;
In the intake and outlet area should not be any solid obstruction within 0,5 m. Motor shaft horizontal.
The information is only valid under the specified test conditions and may be changed by the installation conditions. If there are deviations from the standard test conditions, the characteristic values must be checked under the installed conditions.

a.) Operation condition:

9.200 1/min at free air flow	PWM 100 %; f: 2 kHz		
------------------------------	---------------------	--	--

Max. free-air flow ($\Delta p = 0 / \dot{V} = \text{max.}$)	630 m ³ /h	
Max. static pressure ($\Delta p = \text{max.} / \dot{V} = 0$)	1.500 Pa	

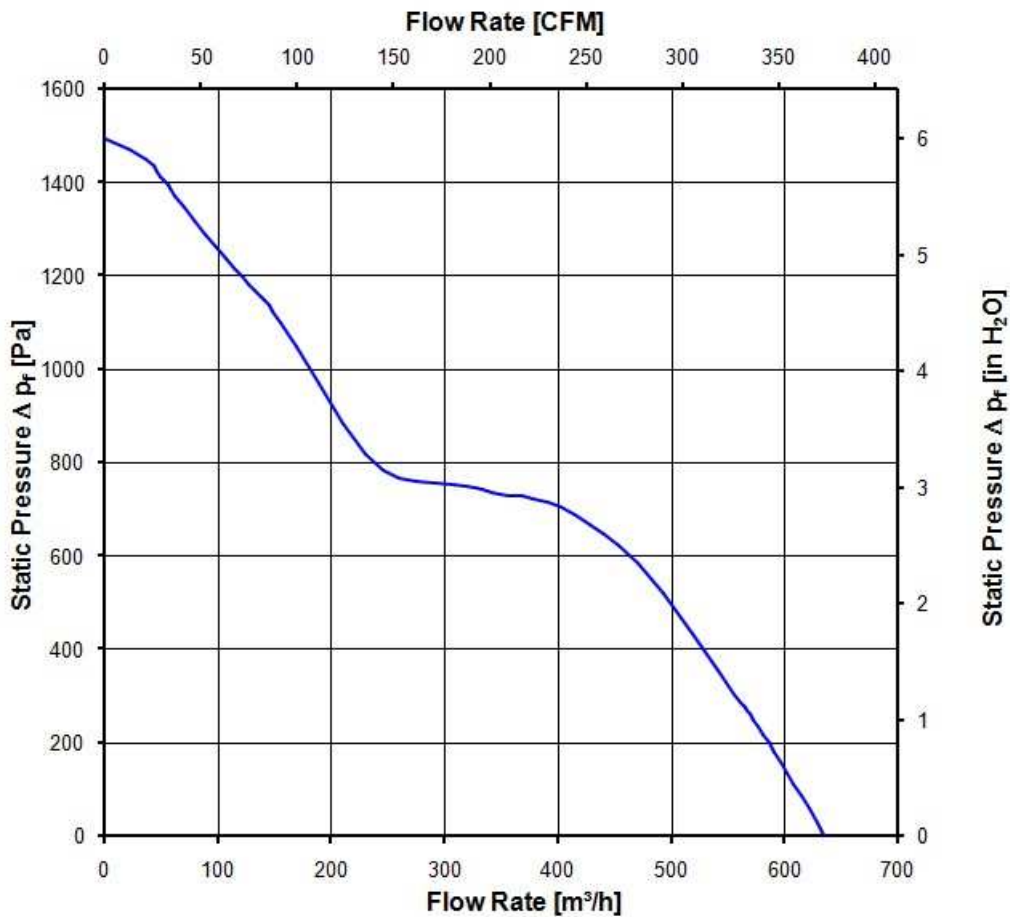

3.7 Sound Data

Measurement conditions: Sound pressure level: 1 meter distance between microphone and the air intake.
Sound power level: Acc. to DIN 45635 part 38 (ISO 10302)
Measured in a semianchoic chamber with a background noise level of $L_p(A) < 5 \text{ dB(A)}$
For further measurement conditions see chapter aerodynamics.

a.) Operation condition:

9.200 1/min at free air flow	PWM 100 %; f: 2 kHz		
------------------------------	---------------------	--	--

Optimal operating point	320 m ³ /h @ 670 Pa		
Sound power level at the optimal operating point	8,8 bel(A)		
Sound pressure level at free air flow, measured in rubber bands	79,0 dB(A)		

4 Environment

4.1 General

Min. permitted ambient temperature TU min.	-20 °C		
Max. permitted ambient temperature TU max.	65 °C		
Min. permitted storage temperature TL min.	-40 °C		
Max. permitted storage temperature TL max.	80 °C		

4.2 Climatic Requirements

Humidity requirements	humid heat, constant; according to DIN EN 60068-2-78, 14 days		
Water exposure	None		
Dust requirements	None		
Salt fog requirements	None		

Permitted application area:

The product is intended for use in sheltered rooms with controlled temperature and controlled humidity. Directly exposure to water must be avoided.

Pollution degree 1 (according DIN EN 60664-1)

There is either no pollution or it occurs only dry, non-conductive pollution. The pollution has no negative impact.

Please require severity levels and specification parameters from the responsible development departments.

5 Safety

5.1 Electrical Safety

Dielectric strength DIN EN 60950 (VDE 0805) and DIN EN 60335 (VDE 0700) A.) Type test Measuring conditions: After 48h of storage at 95% R.H. and 25°C. No arcing or breakdown is allowed! All connections together to ground.	1000 VAC / 1 Min.	
B.) Routine test Measuring conditions: At indoor climate. No arcing or breakdown is allowed! All connections together to ground.	1700 VDC / 1 Sec.	
Isolation resistance Measuring conditions: After 48h of storage at 95% R.H. and 25°C measured with U=500 VDC for 1 min.	RI > 10 MOhm	
Clearance / creepage distance	1,0 mm / 1,5 mm	
Protection class	I	

5.2 Approval Tests

CE	EC Declaration of Conformity	No
EAC	Eurasian Conformity	Yes
UL	Underwriters Laboratories	Yes / UL audited by CSA according to UL507, Electric Fans
VDE	Association for Electrical, Electronic and Information Technologies	Yes / Approval acc. to EN 60950 (VDE 0805) - Information technology equipment
CSA	Canadian Standards Association	Yes / C22.2 No. 113 Fans and Ventilators
CCC	China Compulsory Certification	Yes / GB 12350 Safety Requirements for small Power Motors

The approval tests are observed to:

U approval max.: 72,0 V @ TU approval max.: 65,0 °C

6 Reliability

6.1 General

Life expectancy L10 at TU = 40 °C	57.500 h	
Life expectancy L10 at TU max.	32.500 h	
Life expectancy L10 acc. to IPC 9591 at TU = 40 °C	97.5 00 h	

