

Product Data Sheet 4184 N/17X

**ebmpapst**

The engineer's choice



## 4184 N/17X

## INDEX

<b>1</b>	<b>General</b> .....	<b>3</b>
<b>2</b>	<b>Mechanics</b> .....	<b>3</b>
2.1	General.....	3
2.2	Connections.....	3
<b>3</b>	<b>Operating Data</b> .....	<b>4</b>
3.1	Electrical Operating Data .....	4
3.2	Electrical Interface - Output.....	5
3.3	Electrical Features .....	5
3.4	Aerodynamics .....	7
3.5	Sound Data.....	8
<b>4</b>	<b>Environment</b> .....	<b>8</b>
4.1	General.....	8
4.2	Climatic Requirements .....	8
<b>5</b>	<b>Safety</b> .....	<b>9</b>
5.1	Electrical Safety .....	9
5.2	Approval Tests .....	9
<b>6</b>	<b>Reliability</b> .....	<b>9</b>
6.1	General.....	9

**1 General**

Fan type	Fan	
Rotating direction looking at rotor	Clockwise	
Airflow direction	Air intake over struts	
Bearing system	Ball bearing	
Mounting position - shaft	Any	

**2 Mechanics**

**2.1 General**

Width	119,0 mm	
Height	119,0 mm	
Depth	38,0 mm	
Mass	0,390 kg	
Housing material	Metal	
Impeller material	Plastic	
Max. torque when mounted across both mounting flanges	Wire outlet corner: 170 Ncm Remaining corners: 300 Ncm	
Screw size	ISO 4762 - M3 degreased, without an additional brace and without washer	

**2.2 Connections**

Electrical connection	Plug	
Lead wire length	L = 310 mm	
Tolerance	+ - 10,0 mm	
Plug	See drawing	
Contact	See drawing	

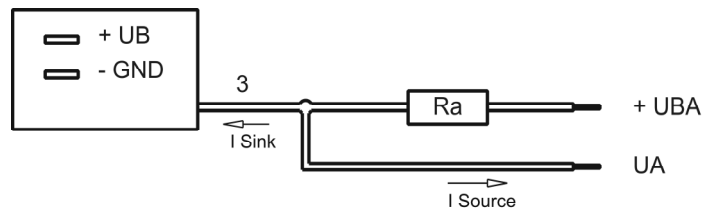

Wire	Color	Operation	Wire size	Insulation diameter
3	white	Alarm	AWG 22	1,7 mm

The auxiliaries shown on the schematic diagram (which are required for the intended use) are not part of our delivery.

### 3 Operating Data

#### 3.1 Electrical Operating Data

Measurement conditions: Normal air density = 1,2 kg/m<sup>3</sup>; Temperature 23°C +/- 3°C; Motor axis horizontal; warm-up time before measuring 5 minutes (unless otherwise specified). In the intake and outlet area should not be any solid obstruction within 0,5 m.

$\Delta p = 0$ : corresp. to free air flow (see chapter aerodynamics)  
 I: corresp. to arithm. mean current value

Features	Condition	Symbol	Values		
Voltage range		U	18 V		32 V
Nominal voltage		$U_N$		24 V	
Power consumption	$\Delta p = 0$	P	3,2 W	5,9 W	6,2 W
Tolerance	0010		+/- 25 %	+/- 25 %	+/- 25 %
Current consumption	$\Delta p = 0$	I	180 mA	245 mA	195 mA
Tolerance	0010		+/- 25 %	+/- 25 %	+/- 25 %
Speed	$\Delta p = 0$	n	2.450 1/min	3.200 1/min	3.200 1/min
Tolerance	0010		+/- 12,5 %	+/- 2 %	+/- 2 %
Starting current consumption				1.200 mA	

### 3.2 Electrical Interface - Output

Alarm type	/17 (high = ok, open collector)
------------	---------------------------------

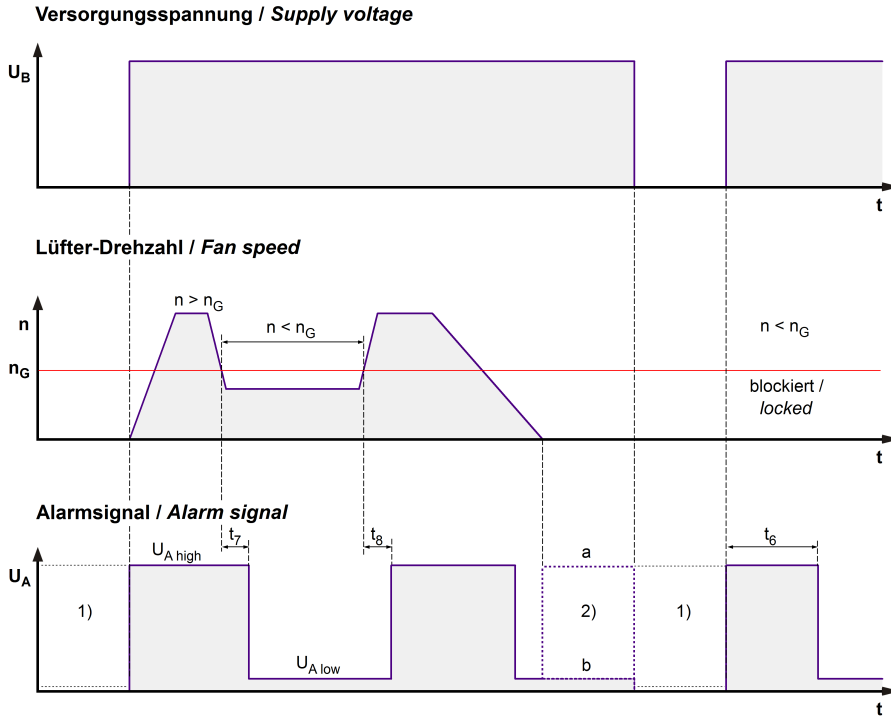

$$R_a = \frac{U_{BA} - U_{A\text{low}}}{I_{\text{sink}}}$$

Lüfter / Fan      Kunde / Customer

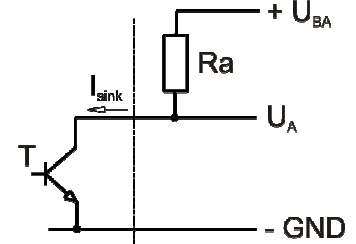

- 1) Wenn der Lüfter abgeschaltet ist, hängt der Zustand des Ausgangssignals  $U_A$  von der Kundenapplikation ab.  
 When the fan is powered off, the output signal  $U_A$  depends on the customer's application.  
 2) Für den gültigen Zustand (a oder b) siehe Alarmunterdrückung in der Tabelle.  
 For the valid condition (a or b) see alarm suppression in the table.

Features	Note	Values
Alarm operating voltage	$U_{BA}$	$\leq 60 \text{ V}$
Alarm signal Low	$U_{A\text{low}}$	$\leq 0,4 \text{ V}$
Maximum sink current	$I_{\text{sink}}$	20 mA
External resistor	External resistor $R_a$ from $U_{BA}$ to $U_A$ required. All voltage measured to GND.	
Alarm start-up delay time	$t_6$	$\leq 15 \text{ s}$
Alarm trip speed limit	$n_G$	1.500 1/min +/- 100 1/min
Tolerance		
Alarm at sense failure	No	
Alarm latch	No	
Alarm isolated from motor	No	

### 3.3 Electrical Features

Electronic function	Speed-Controlled	
Reversed polarity protection	Rectifying diode	
Max. residual current at $U_N$	$I_F \leq 20 \text{ mA}$	
Locked rotor protection	Auto restart	
Locked rotor current at $U_N$	$I_{\text{block}}$ approx. 1.200 mA	
Clock signal at locked rotor	$t_3 / t_4$ typical: 0,4 s / 10 s	

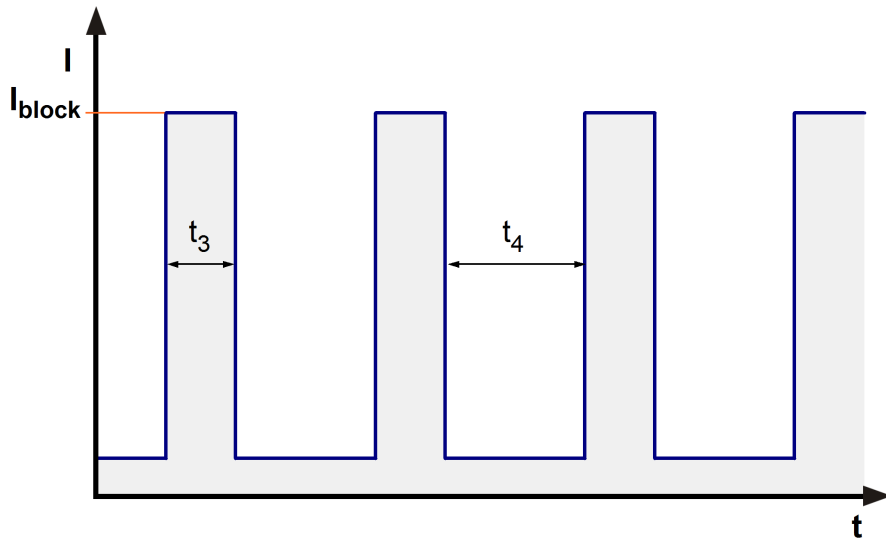

### 3.4 Aerodynamics

Measurement conditions:

Measured with a double chamber intake rig acc. to DIN EN ISO 5801.

Normal air density = 1,2 kg/m<sup>3</sup>; Temperature 23°C +/- 3°C;

In the intake and outlet area should not be any solid obstruction within 0,5 m. Motor shaft horizontal.

The information is only valid under the specified test conditions and may be changed by the installation conditions. If there are deviations from the standard test conditions, the characteristic values must be checked under the installed conditions.

a.) Operation condition:

3.200 1/min at free air flow

Max. free-air flow ( $\Delta p = 0 / \dot{V} = \text{max.}$ )	168,0 m <sup>3</sup> /h	
Max. static pressure ( $\Delta p = \text{max.} / \dot{V} = 0$ )	100 Pa	

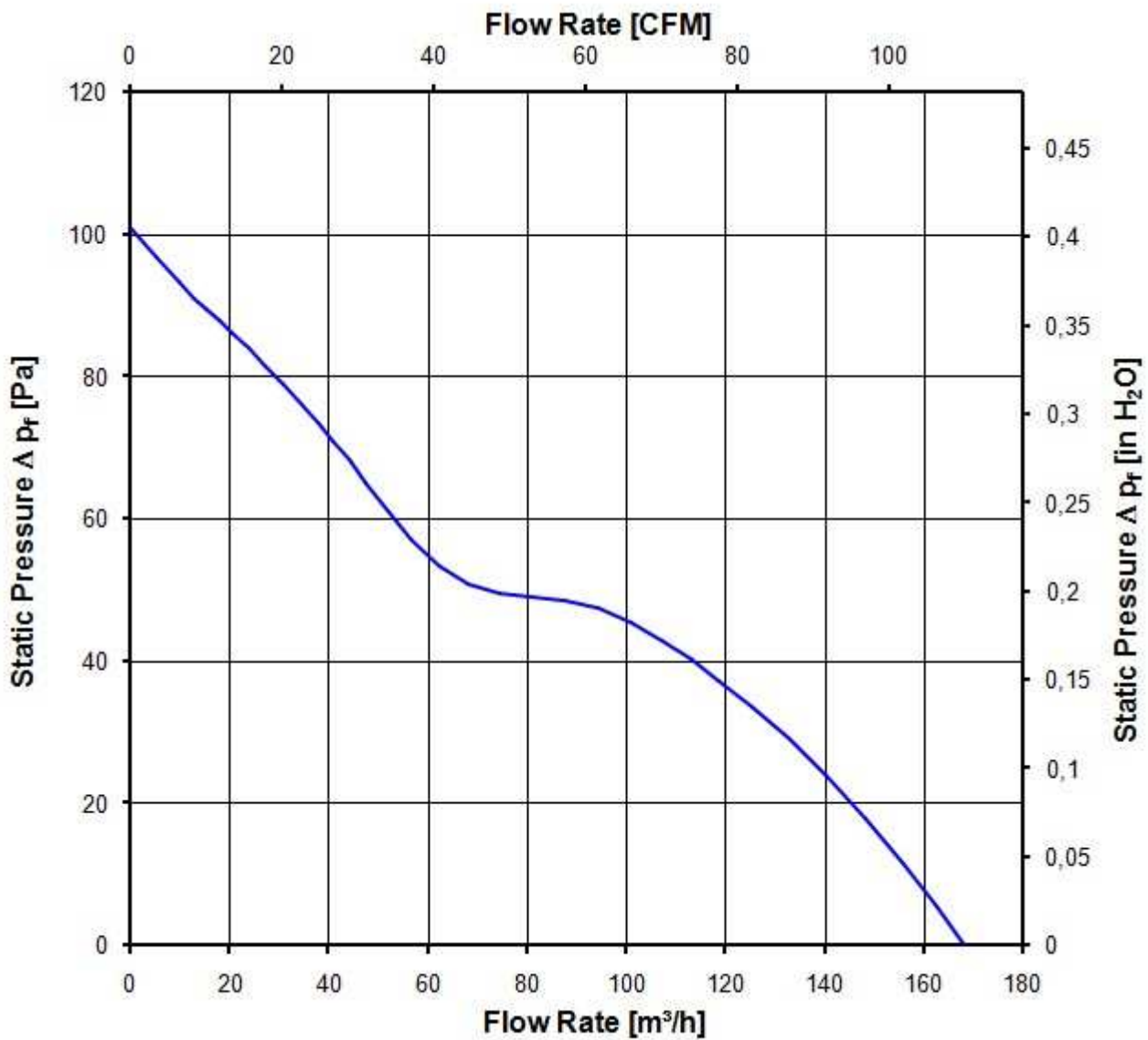

### 3.5 Sound Data

Measurement conditions: Sound pressure level: 1 meter distance between microphone and the air intake.  
 Sound power level: Acc. to DIN 45635 part 38 (ISO 10302)  
 Measured in a semianchoic chamber with a background noise level of  $L_p(A) < 5 \text{ dB(A)}$   
 For further measurement conditions see chapter aerodynamics.

a.) Operation condition:

3.200 1/min at free air flow

Optimal operating point	104,0 m <sup>3</sup> /h @ 40 Pa	
Sound power level at the optimal operating point	5,6 bel(A)	
Sound pressure level at free air flow, measured in rubber bands	49,0 dB(A)	

## 4 Environment

### 4.1 General

Min. permitted ambient temperature TU min.	-30 °C	
Max. permitted ambient temperature TU max.	75 °C	
Min. permitted storage temperature TL min.	-40 °C	
Max. permitted storage temperature TL max.	80 °C	

### 4.2 Climatic Requirements

Humidity requirements	humid heat, constant; according to DIN EN 60068-2-78, 14 days	
Water exposure	None	
Dust requirements	None	
Salt fog requirements	None	

Permitted application area:

The product is intended for use in sheltered rooms with controlled temperature and controlled humidity. Directly exposure to water must be avoided.

Pollution degree 1 (according DIN EN 60664-1)

There is either no pollution or it occurs only dry, non-conductive pollution. The pollution has no negative impact.

Please require severity levels and specification parameters from the responsible development departments.



## 5 Safety

### 5.1 Electrical Safety

Dielectric strength DIN EN 60950 (VDE 0805) and DIN EN 60335 (VDE 0700) A.) Type test Measuring conditions: After 48h of storage at 95% R.H. and 25°C. No arcing or breakdown is allowed! All connections together to ground. B.) Routine test Measuring conditions: At indoor climate. No arcing or breakdown is allowed! All connections together to ground.	500 VAC / 1 Min.  850 VDC / 1 Sec.	
Isolation resistance Measuring conditions: After 48h of storage at 95% R.H. and 25°C measured with U=500 VDC for 1 min.	RI > 10 MOhm	
Clearance / creepage distance	1,0 mm / 1,2 mm	
Protection class	III	

### 5.2 Approval Tests

CE	EC Declaration of Conformity	Yes
EAC	Eurasian Conformity	Yes
UL	Underwriters Laboratories	Yes / UL507, Electric Fans
VDE	Association for Electrical, Electronic and Information Technologies	Yes / Approval acc. to EN 60950 (VDE 0805) - Information technology equipment
CSA	Canadian Standards Association	Yes / C22.2 No. 113 Fans and Ventilators
CCC	China Compulsory Certification	Not applicable

## 6 Reliability

### 6.1 General

Copying of this document, and giving it to others and the use or communication of the contents thereof, are forbidden without express authority. Offenders are liable to the payment of damages. All rights are reserved in the event of the grant of a patent or the registration of a utility model or design.

Schutzvermerk nach DIN ISO 16046 beachten/  
Refer to protection notice DIN ISO 16046!

Maße für  
Steckeranschluss

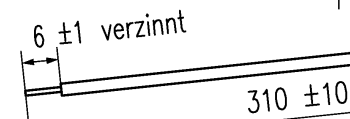
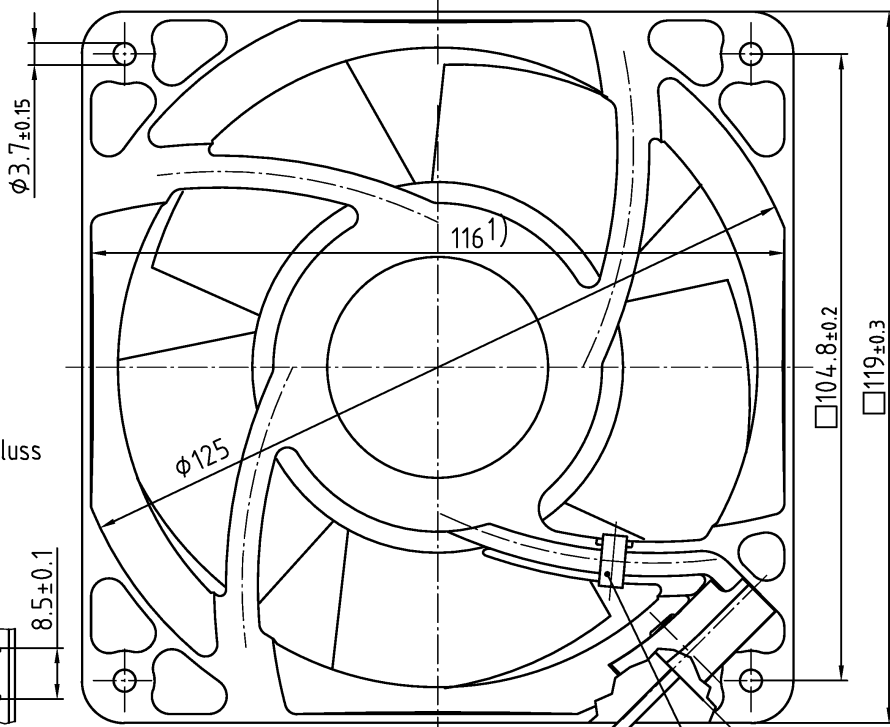
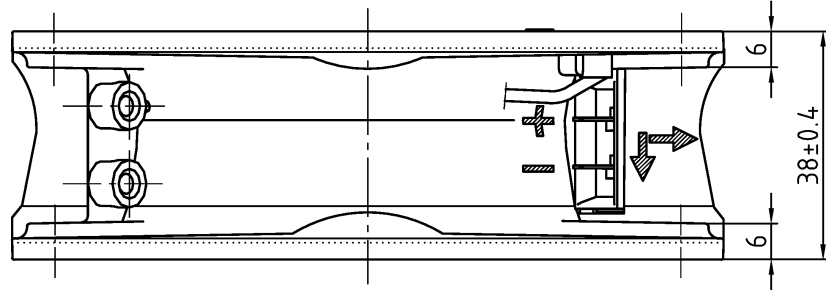
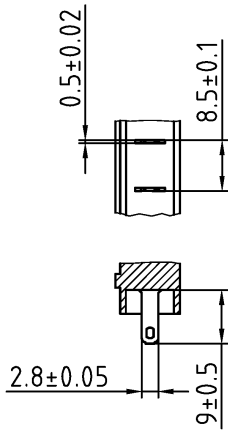

1) Maße für Montagewand

Axialspiel bei  
 - Kugellagerung (K): 0 (mit Federausgleich)  
 - Gleitlagerung (G): 0.1 - 0.6

Tolerierung/Tolerances: DIN 7167			
Allgemeintoleranzen/ Gen. tolerances:			
	Datum/Date	Name/Name	Artikel/Title
Bearb./Drawn:			Massstab/scale
	Index/Index	Aend.-Nr./Change-No.	Zchg.-Nr./ Dwg.-No.:
gepr. u. zur Verwendung freigegeben/Checked for release von/am by/on		<b>ebmpapst</b> ebm-papst St. Georgen GmbH & Co. KG	Blatt/Page Ers.f.Zchg./ Replaces:
			A4