

**Product Data Sheet**    **9694300309**  
VUC0119YUJBS  
4114 N/2H3P-309

**ebmpapst**

The engineer's choice

4114N/2H3P-309 (9694300309) ebmpapst Datasheet FansCo  
sales@fansco.com  
www.fansco.com



4114N/2H3P-309 (9694300309) ebmpapst Datasheet FansCo sales@fansco.com www.fansco.com



4114 N/2H3P-309

INDEX

**1 General ..... 3**

**2 Mechanics ..... 3**

2.1 General..... 3

2.2 Connections..... 3

**3 Operating Data ..... 4**

3.1 Electrical Interface - Input..... 4

3.2 Electrical Operating Data ..... 5

3.3 Electrical Interface - Output..... 6

3.4 Electrical Features ..... 7

3.5 Aerodynamics ..... 8

3.6 Sound Data..... 9

**4 Environment..... 9**

4.1 General..... 9

4.2 Climatic Requirements ..... 9

**5 Safety..... 10**

5.1 Electrical Safety ..... 10

5.2 Approval Tests ..... 10

**6 Reliability..... 10**

6.1 General..... 10

1 General

Fan type	Fan	
Rotating direction looking at rotor	Clockwise	
Airflow direction	Air intake over struts	
Bearing system	Ball bearing	
Mounting position - shaft	Any	

2 Mechanics

2.1 General

Width	119,0 mm	
Height	119,0 mm	
Depth	38,0 mm	
Mass	0,390 kg	
Housing material	Metal	
Impeller material	Plastic	
Max. torque when mounted across both mounting flanges	Wire outlet corner: 420 Ncm Remaining corners: 560 Ncm	
Screw size	ISO 4762 - M4 degreased, without an additional brace and without washer	

2.2 Connections

Electrical connection	Wires	
Lead wire length	L = 500 mm	
Tolerance	+/- 10 mm	

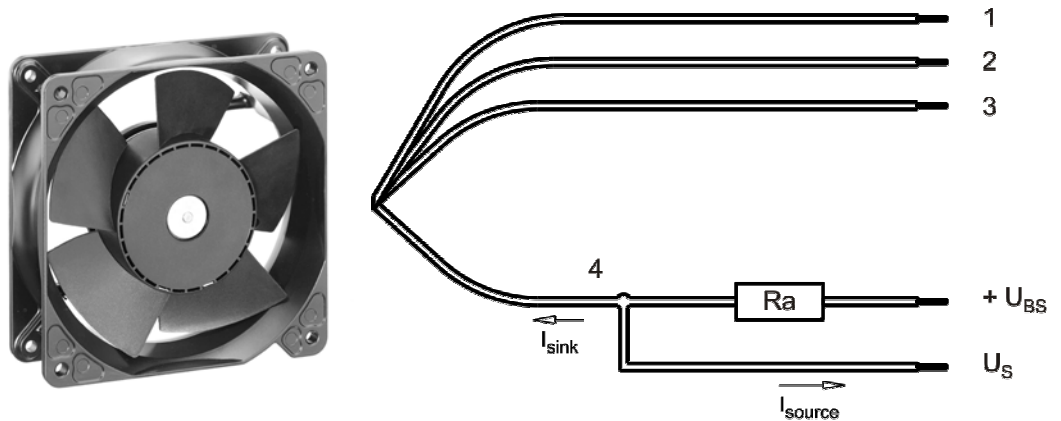

Wire	Color	Operation	Wire size	Insulation diameter
1	red	+ UB	AWG 22	1,7 mm
2	blue	- GND	AWG 22	1,7 mm
3	violet	PWM	AWG 22	1,7 mm
4	white	Tacho	AWG 22	1,7 mm

The auxiliaries shown on the schematic diagram (which are required for the intended use) are not part of our delivery.

3 Operating Data

3.1 Electrical Interface - Input

Control input	PWM
---------------	-----

Features

Input type	Open collector	
PWM - Frequency		1 kHz - 10 kHz typical: 2 kHz

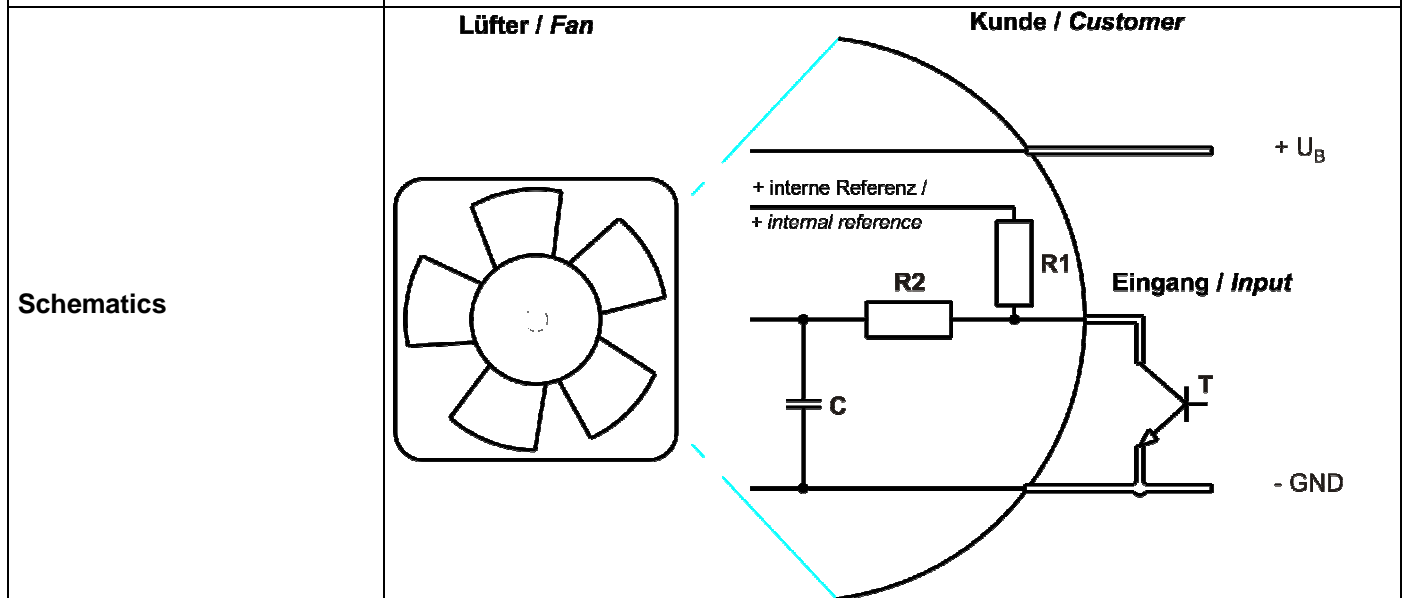
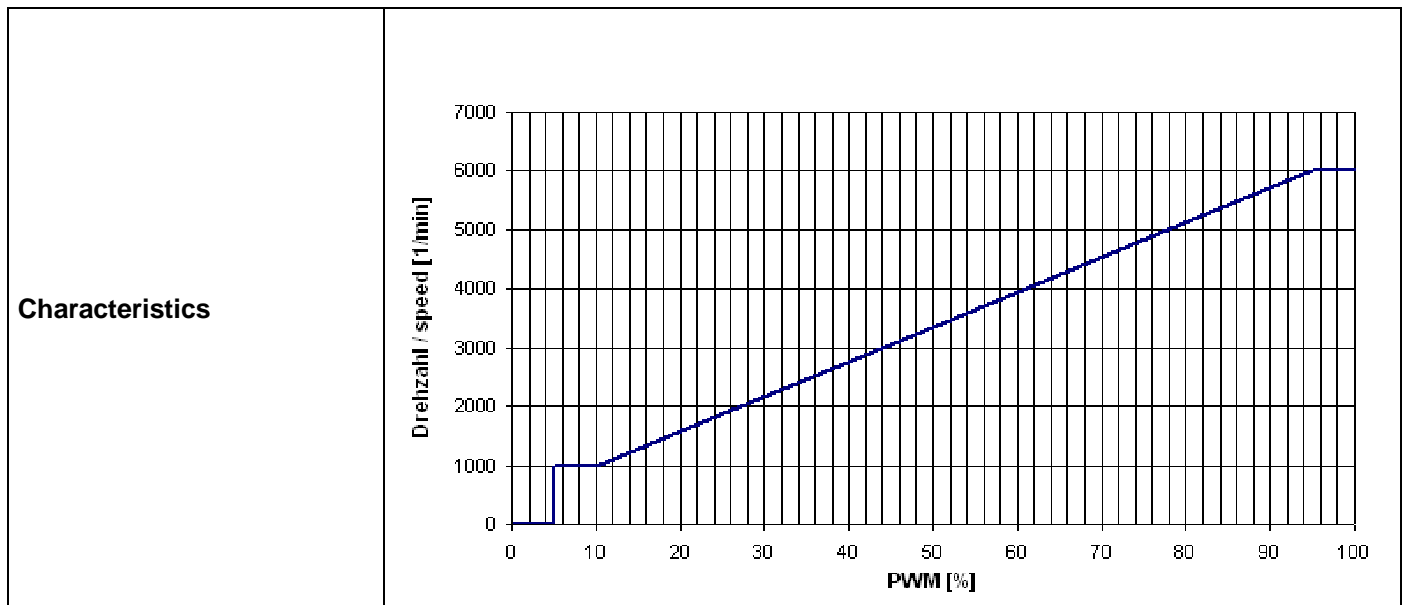

**Speed control:**  
 0...100 % PWM; 5 V pull-up, max 2 mA

**Transistor requirements:**  
 VCEmax. >12V

Isink max. >5mA  
VCEsat <0,15V

### 3.2 Electrical Operating Data

Measurement conditions: Normal air density = 1,2 kg/m<sup>3</sup>; Temperature 23°C +/- 3°C; Motor axis horizontal; warm-up time before measuring 5 minutes (unless otherwise specified). In the intake and outlet area should not be any solid obstruction within 0,5 m.

$\Delta p = 0$ : corresp. to free air flow (see chapter aerodynamics)  
I: corresp. to arithm. mean current value

Name	Condition
PWM 0001	PWM: 100 %; f: 2 kHz

**Note:**

**No inrush current at Unom means:**

The internal electrolytic capacitor 120uF/50V has no resistor or inrush current limitation, essentially the type and length of the connecting cable is limiting the Inrush current.

Features	Condition	Symbol	Values		
Voltage range		U	16 V		30 V
Nominal voltage		U <sub>N</sub>		24 V	
Power consumption	$\Delta p = 0$	P	9 W	22 W	25,2 W
Tolerance	PWM 0010		+/- 15 %	+/- 10 %	+/- 10 %
Current consumption	$\Delta p = 0$	I	560 mA	920 mA	840 mA
Tolerance	PWM 0010		+/- 15 %	+/- 10 %	+/- 10 %
Speed	$\Delta p = 0$	n	4.300 1/min	6.000 1/min	6.000 1/min
Tolerance	PWM 0010		+/- 10 %	+/- 10,0 %	+/- 7,5 %
Starting current consumption				<= 2.500 mA	

3.3 Electrical Interface - Output

Tacho type	/2 (open collector)
------------	---------------------

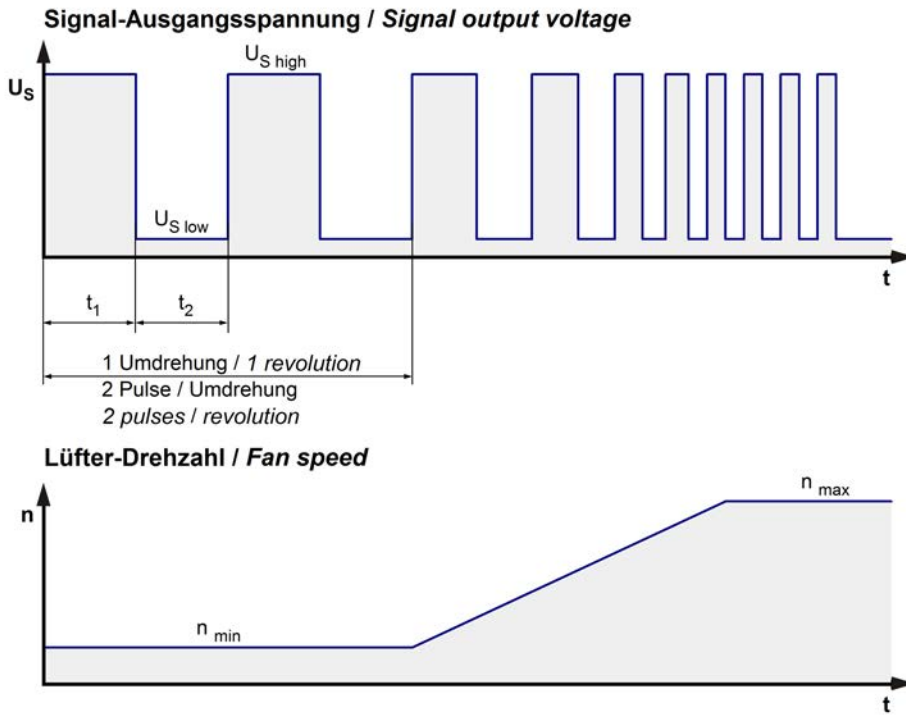

$$R_a = \frac{U_{BS} - U_{S\ low}}{I_{sink}}$$

Lüfter / Fan      Kunde / Customer

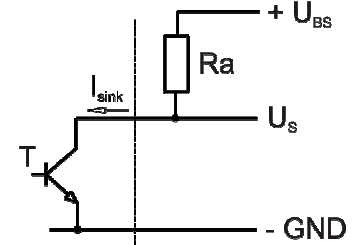

Features	Note	Values
Tacho operating voltage	$U_{BS}$	$\leq 60\ V$
Tacho signal Low	$U_{S\ low}$	$\leq 0,4\ V$
Tacho signal High	$U_{S\ high}$	$60\ V$
Maximum sink current	$I_{sink}$	$\leq 10\ mA$
External resistor	External resistor $R_a$ from $U_{BS}$ to $U_s$ required. All voltages measured to GND.	
Tacho frequency	$(2 \times n) / 60$	
Tacho isolated from motor	No	
Slew rate		$\Rightarrow 0,5\ V/\mu s$

$n$  = revolutions per minute (1/min)

3.4 Electrical Features

Electronic function	Speed-Controlled	
Reversed polarity protection	Rectifying diode	
Max. residual current at $U_N$	$I_F \leq 10 \text{ mA}$	
Locked rotor protection	Auto restart	
Locked rotor current at $U_N$	$I_{\text{block}}$ approx. 1.600 mA	
Clock signal at locked rotor	$t_3 / t_4$ typical: 0,5 s / 5,0 s	

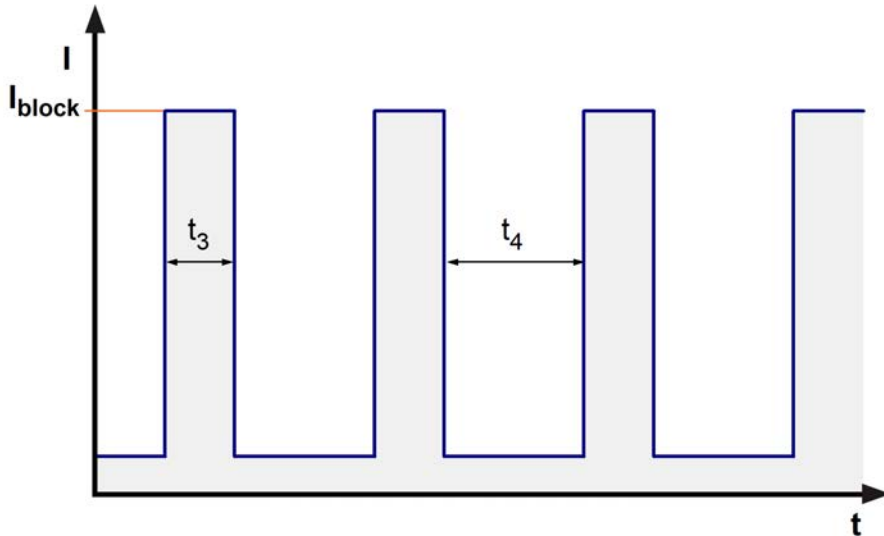

Max. current when decelerate at  $U_{\text{nom.}} = < 2.600\text{mA}$

Internal Fuse:

Littlefuse NANO2(R) FUSE; Very fast acting 451 Series; 4 A (Art.-No.: 451004)

3.5 Aerodynamics

Measurement conditions: Measured with a double chamber intake rig acc. to DIN EN ISO 5801.  
 Normal air density = 1,2 kg/m<sup>3</sup>; Temperature 23°C +/- 3°C;  
 In the intake and outlet area should not be any solid obstruction within 0,5 m. Motor shaft horizontal.  
 The information is only valid under the specified test conditions and may be changed by the installation conditions. If there are deviations from the standard test conditions, the characteristic values must be checked under the installed conditions.

a.) Operation condition:

6.000 1/min at free air flow	PWM 100 %; f: 2 kHz		
------------------------------	---------------------	--	--

Max. free-air flow ( $\Delta p = 0 / \dot{V} = \text{max.}$ )	310,0 m <sup>3</sup> /h	
Max. static pressure ( $\Delta p = \text{max.} / \dot{V} = 0$ )	320 Pa	

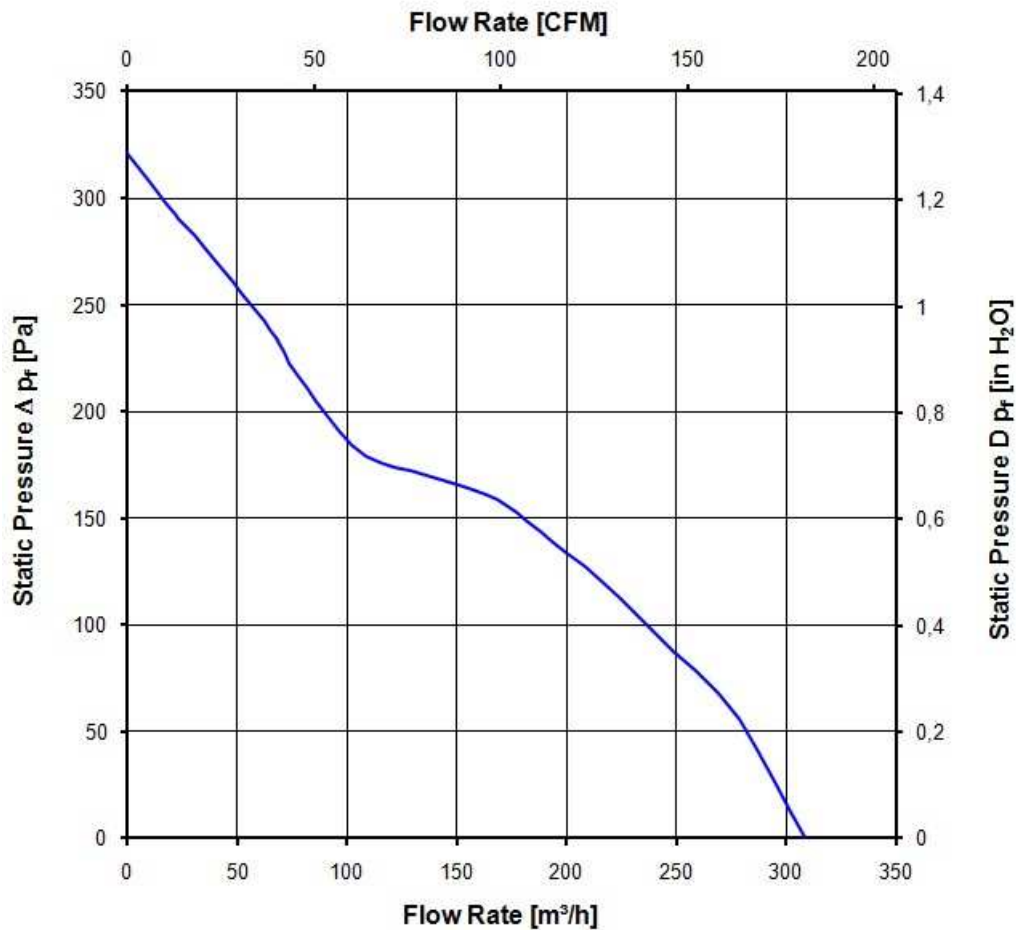

### 3.6 Sound Data

Measurement conditions: Sound pressure level: 1 meter distance between microphone and the air intake.

Measured in a semianchoic chamber with a background noise level of  $L_p(A) < 5 \text{ dB(A)}$   
For further measurement conditions see chapter aerodynamics.

a.) Operation condition:

6.000 1/min at free air flow	PWM 100 %; f: 2 kHz		
------------------------------	---------------------	--	--

## 4 Environment

### 4.1 General

Min. permitted ambient temperature TU min.	-20 °C	
Max. permitted ambient temperature TU max.	65 °C	
Min. permitted storage temperature TL min.	-40 °C	
Max. permitted storage temperature TL max.	80 °C	

### 4.2 Climatic Requirements

Humidity requirements	humid heat, constant; according to DIN EN 60068-2-78, 14 days	
Water exposure	None	
Dust requirements	None	
Salt fog requirements	None	

Permitted application area:

The product is intended for use in sheltered rooms with controlled temperature and controlled humidity. Directly exposure to water must be avoided.

Pollution degree 1 (according DIN EN 60664-1)

There is either no pollution or it occurs only dry, non-conductive pollution. The pollution has no negative impact.

Please require severity levels and specification parameters from the responsible development departments.

## 5 Safety

### 5.1 Electrical Safety

Dielectric strength DIN EN 60950 (VDE 0805) and DIN EN 60335 (VDE 0700) A.) Type test Measuring conditions: After 48h of storage at 95% R.H. and 25°C. No arcing or breakdown is allowed! All connections together to ground.	500 VAC / 1 Min.	
B.) Routine test Measuring conditions: At indoor climate. No arcing or breakdown is allowed! All connections together to ground.	850 VDC / 1 Sec.	
Isolation resistance Measuring conditions: After 48h of storage at 95% R.H. and 25°C measured with U=500 VDC for 1 min.	RI > 10 MOhm	
Clearance / creepage distance	1,0 mm / 1,2 mm	
Protection class	III	

### 5.2 Approval Tests

CE	EC Declaration of Conformity	Yes
EAC	Eurasian Conformity	Yes
UL	Underwriters Laboratories	Yes / UL507, Electric Fans E38324
VDE	Association for Electrical, Electronic and Information Technologies	Yes / Approval acc. to EN 60950 (VDE 0805) - Information technology equipment
CSA	Canadian Standards Association	Yes / C22.2 No. 113 Fans and Ventilators
CCC	China Compulsory Certification	Not applicable

## 6 Reliability

### 6.1 General

Life expectancy L10 at TU = 40 °C	65.000 h	
Life expectancy L10 at TU max.	37.500 h	
Life expectancy L10 acc. to IPC 9591 at TU = 40 °C	110.000 h	

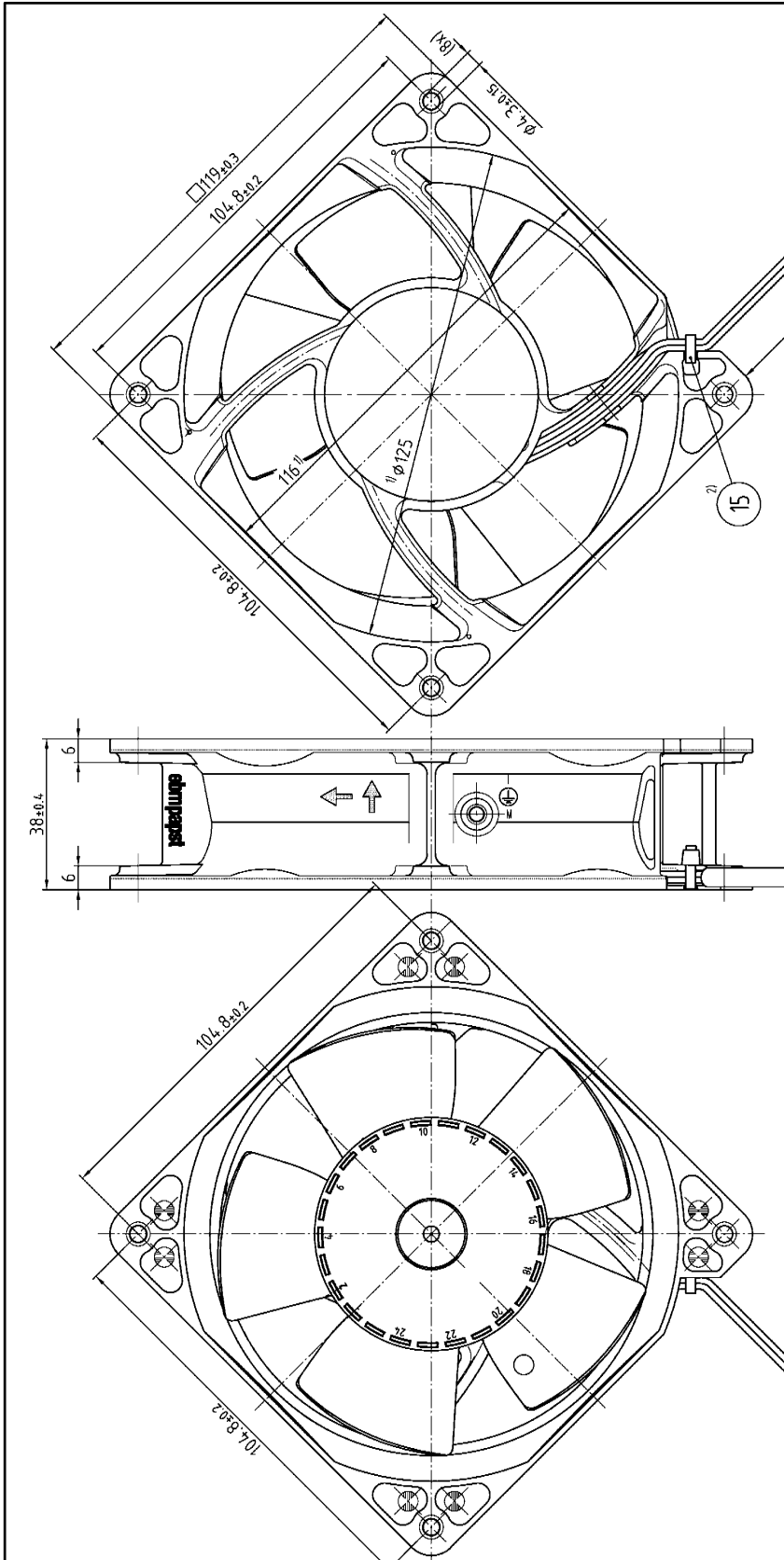

- 1) = Maße für Montagewand
- Axialspiel bei Kugellagerung (K) : 0 (durch Federausgleich)
- Axialspiel bei Gleitlagerung (G) : 0,1 bis 0,5
- 2) = Mit Handhabungswerkzeug montieren.

Kopf darf nach Montage nicht über Außenkontur des Lüftergehäuses stehen

- 1) = Measures for prefab wall
  - Axial play with ball bearing (K): 0 (by spring compensation)
  - Axial play with sleeve bearing (G): 0.1 to 0.5
  - 2) = With handling tool installed.
- Head may not stand over outer contour of the fan housing after assembly

Leitungslänge siehe Produktspezifikation  
For conduit length see product specification

3M-Schneidziele	Icon for drawing file	Artikel / System-Verknüpfung	Hersteller/Material	Volumen/Volume (mm³)
Tolerierung/Tolerances	Icon for drawing file	Hersteller / Name/Title		Gewicht/Weight (g)
Alle Maßeinheiten/Con. tolerances		Artikel/Title		
DIN ISO 2768-1 u. 2 -mK		axial compact fan		
		Zug-/Hr./Drawing-No.		Einzelteil/Replaces
		ebmpapst		Formel/Form
		ebmpapst St. Georgen GmbH & Co. KG		Material/Mat.

Copyright of this document and giving it to others and the use or communication of the contents thereof are forbidden without express authority. Offenders are liable to the payment of damages. All rights are reserved in the event of the grant of a patent or the registration of a utility model or design.  
Schutzrecht nach DIN ISO 9016 beachtend  
Refer to protection notice DIN ISO 9016