

Product Data Sheet **9293510144**
VWC0092PUGBS
3312 N/2H3PU

ebmpapst

The engineer's choice

3312N/2H3PU (9293510144) ebmpapst Datasheet FansCo
sales@fansco.com
www.fansco.com



3312N/2H3PU (9293510144) ebmpapst Datasheet FansCo sales@fansco.com www.fansco.com



3312 N/2H3PU

INDEX

1 General 3

2 Mechanics 3

2.1 General 3

2.2 Connections 3

3 Operating Data 4

3.1 Electrical Interface - Input 4

3.2 Electrical Operating Data 5

3.3 Electrical Interface - Output 6

3.4 Electrical Features 7

3.5 Aerodynamics 8

3.6 Sound Data 9

4 Environment 9

4.1 General 9

4.2 Climatic Requirements 10

4.3 Mechanical Requirements 11

5 Safety 12

5.1 Electrical Safety 12

5.2 Approval Tests 12

6 Reliability 12

6.1 General 12

1 General

Fan type	Fan	
Rotating direction looking at rotor	Clockwise	
Airflow direction	Air outlet over struts	
Bearing system	Ball bearing	
Mounting position - shaft	Any	

2 Mechanics

2.1 General

Width	92,0 mm	
Height	92,0 mm	
Depth	32,0 mm	
Mass	0,22 kg	
Housing material	Plastic	
Impeller material	Plastic	
Max. torque when mounted across both mounting flanges	Wire outlet corner: 80 Ncm Remaining corners: 80 Ncm	
Screw size	ISO 4762 - M4 degreased, without an additional brace and without washer	

2.2 Connections

Electrical connection	Wires	
Lead wire length	L = 310 mm	
Tolerance	+/- 10,0 mm	
Wire size (AWG)		
Insulation diameter	1,5 mm	

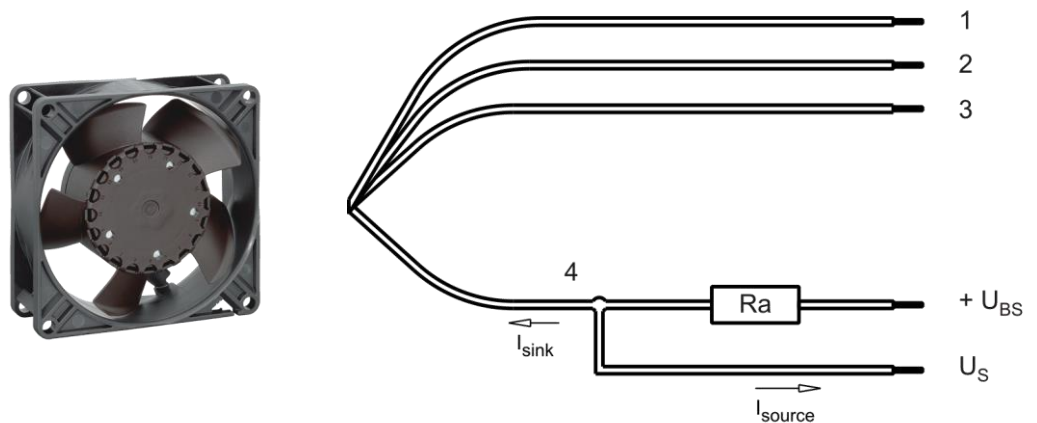

Wire	Color	Operation	Wire size	Insulation diameter
1	red	+ UB	AWG 24	
2	blue	- GND	AWG 24	
3	violet	PWM	AWG 24	
4	white	Tacho	AWG 24	

3 Operating Data

3.1 Electrical Interface - Input

Control input	PWM
---------------	-----

Features

Input type	Open collector	
PWM - Frequency		1 kHz - 30 kHz typical: 25 kHz
Max. voltage for logic "Low"		0,2 V
Maximum source current	short circuit current	≤ 1 mA
Typical time until warm restart	After shutdown by PWM	~ 9 s

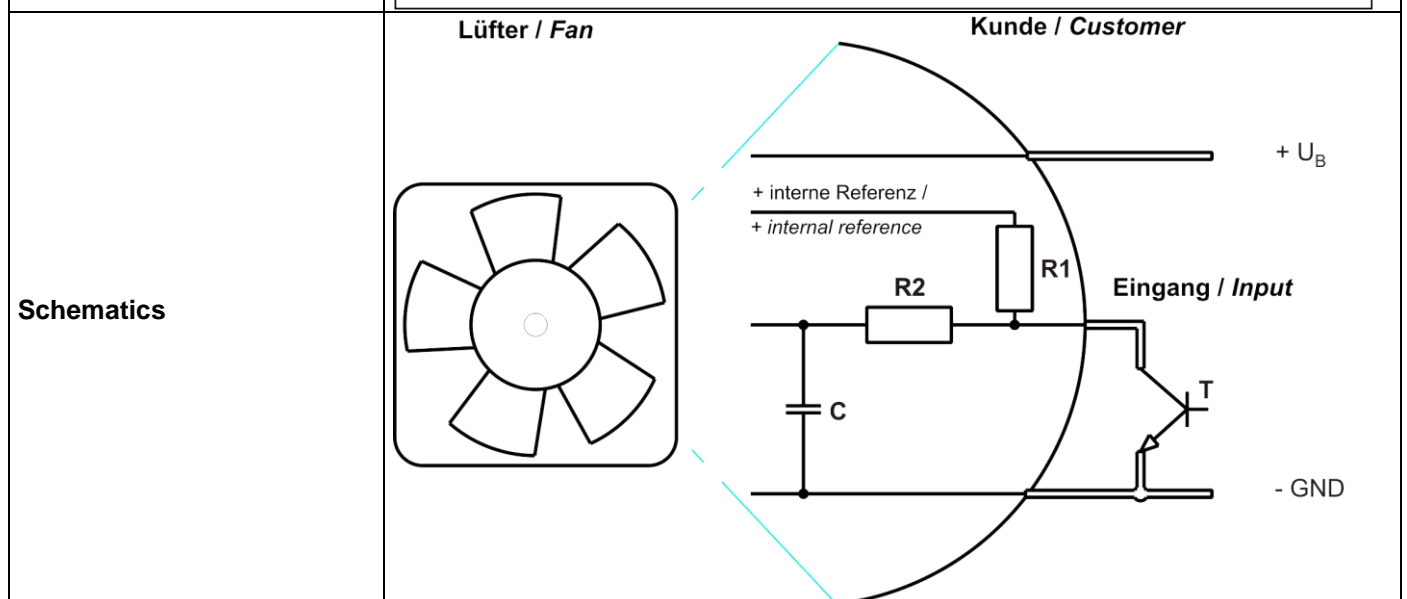
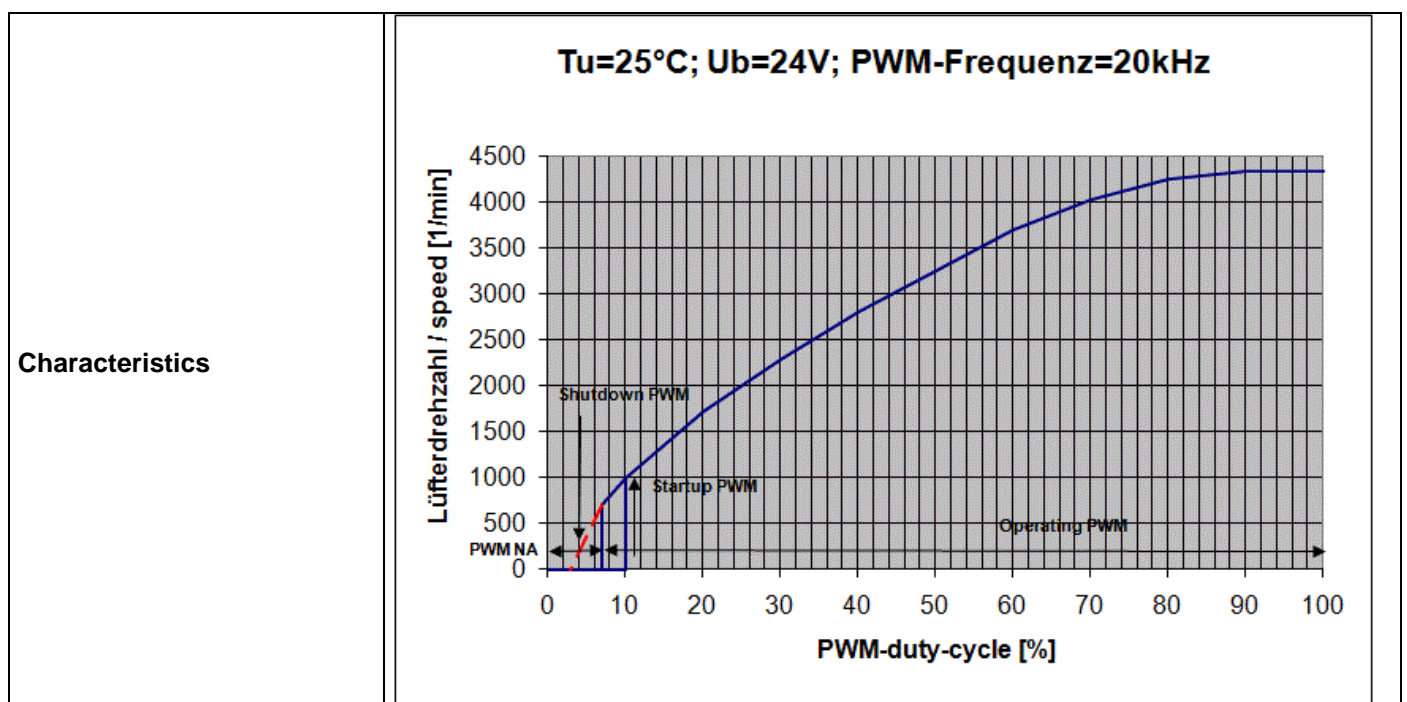

3.2 Electrical Operating Data

Measurement conditions: Normal air density = 1,2 kg/m³; Temperature 23°C +/- 3°C; Motor axis horizontal; warm-up time before measuring 5 minutes (unless otherwise specified). In the intake and outlet area should not be any solid obstruction within 0,5 m.

$\Delta p = 0$: corresp. to free air flow (see chapter aerodynamics)
I: corresp. to arithm. mean current value

Name	Condition		
PWM 0001	PWM: 100 %; f: 25 kHz	f: 1 kHz	f: 30 kHz

Features	Condition	Symbol	Values		
Voltage range		U	7 V		13,2 V
Nominal voltage		U _N		12 V	
Power consumption	$\Delta p = 0$	P	1,7 W	5,5 W	6,7 W
Tolerance	PWM 0010		+/- 20 %	+/- 15 %	+/- 15 %
Current consumption	$\Delta p = 0$	I	240 mA	460 mA	500 mA
Tolerance	PWM 0010		+/- 17,5 %	+/- 15 %	+/- 15 %
Speed	$\Delta p = 0$	n	2.700 1/min	4.350 1/min	4.700 1/min
Tolerance	PWM 0010		+/- 12,5 %	+/- 10 %	+/- 10 %
Starting current consumption				<= 600 mA	

3.3 Electrical Interface - Output

Tacho type	/2 (open collector)
------------	---------------------

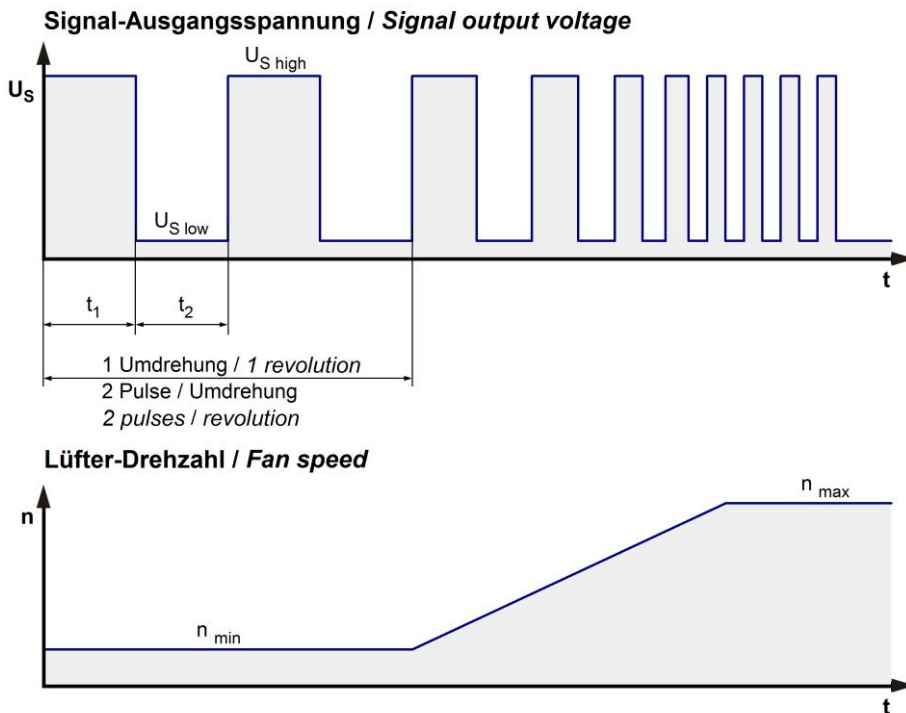

$$R_a = \frac{U_{BS} - U_{S\ low}}{I_{sink}}$$

Lüfter / Fan Kunde / Customer

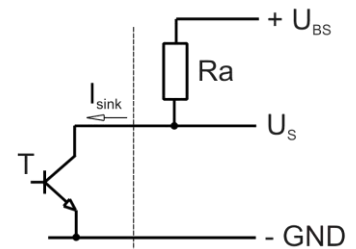

Features	Note	Values
Tacho operating voltage	U_{BS}	$\leq 60\ V$
Tacho signal Low	$U_{S\ low}$	$\leq 0,4\ V$
Tacho signal High	$U_{S\ high}$	$60\ V$
Maximum sink current	I_{sink}	$\leq 4\ mA$
External resistor	External resistor R_a from U_{BS} to U_S required. All voltages measured to GND.	
Tacho frequency	$(2 \times n) / 60$	
Tacho isolated from motor	No	
Slew rate		$\Rightarrow 0,5\ V/\mu s$

n = revolutions per minute (1/min)

3.4 Electrical Features

Electronic function	Speed-Controlled	
Reversed polarity protection	Rectifying diode	
Max. residual current at U_N	$I_F < 200 \mu A$	
Locked rotor protection	Auto restart	
Locked rotor current at U_N	I_{block} approx. 950 mA	
Clock signal at locked rotor	t_3 / t_4 typical: 1 s / 9 s	

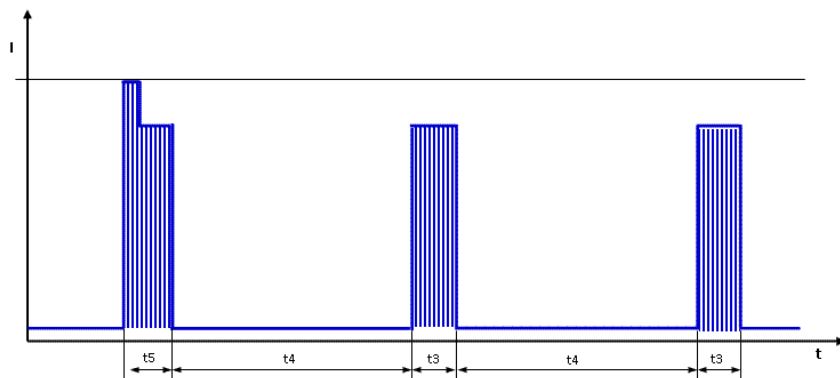

First pulse t_5 typical 1,6s (1,3 .. 1,9s) followed by t_4 . Afterwards cyclical t_3/t_4 .

3.5 Aerodynamics

Measurement conditions: Measured with a double chamber intake rig acc. to DIN EN ISO 5801. Normal air density = 1,2 kg/m³; Temperature 23°C +/- 3°C; In the intake and outlet area should not be any solid obstruction within 0,5 m. Motor shaft horizontal. The information is only valid under the specified test conditions and may be changed by the installation conditions. If there are deviations from the standard test conditions, the characteristic values must be checked under the installed conditions.

a.) Operation condition:

4.350 1/min at free air flow	PWM 100 %; f: 25 kHz	f: 1 kHz	f: 30 kHz
------------------------------	----------------------	----------	-----------

Max. free-air flow ($\Delta p = 0 / \dot{V} = \text{max.}$)	133 m ³ /h	
Max. static pressure ($\Delta p = \text{max.} / \dot{V} = 0$)	130 Pa	

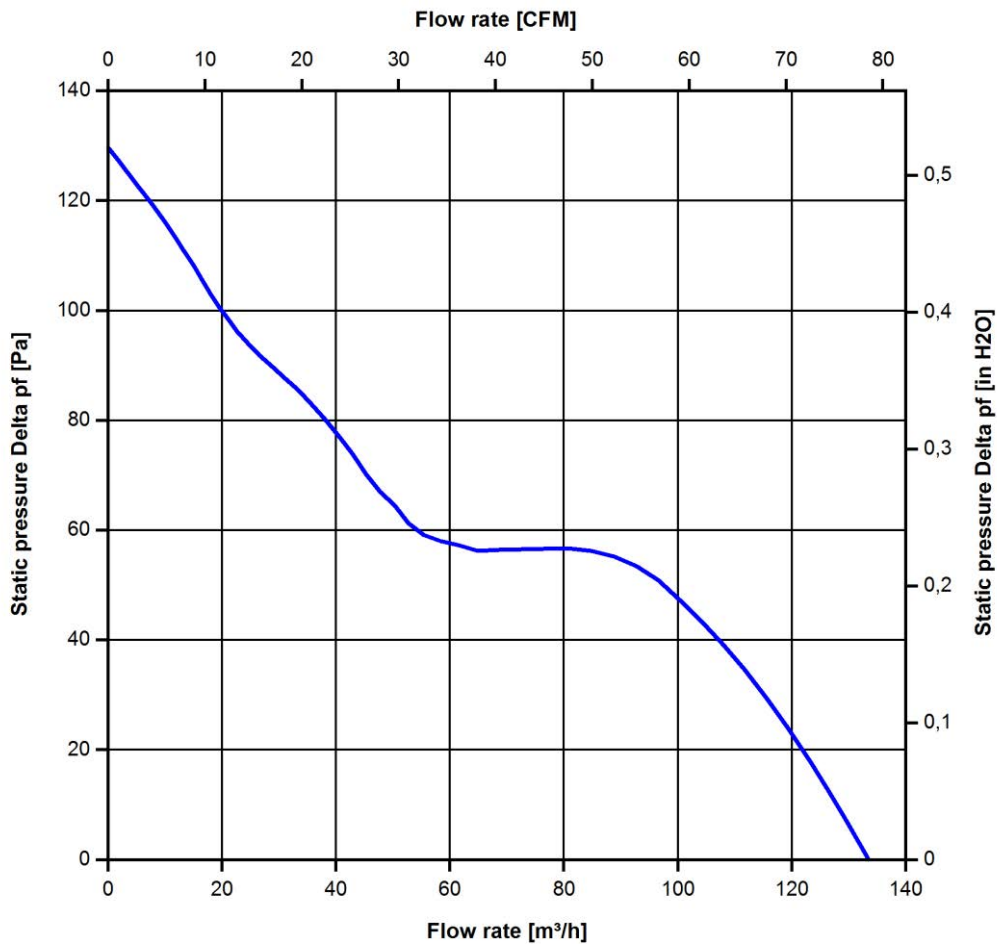

3.6 Sound Data

Measurement conditions: Sound pressure level: 1 meter distance between microphone and the air intake.
 Sound power level: Acc. to DIN 45635 part 38 (ISO 10302)
 Measured in a semianchoic chamber with a background noise level of $L_p(A) < 5 \text{ dB(A)}$
 For further measurement conditions see chapter aerodynamics.

a.) Operation condition:

4.350 1/min at free air flow	PWM 100 %; f: 25 kHz	f: 1 kHz	f: 30 kHz
------------------------------	----------------------	----------	-----------

Optimal operating point	84 m3/h @ 51 Pa	
Sound power level at the optimal operating point	6,0 bel(A)	
Sound pressure level at free air flow, measured in rubber bands	50 dB(A)	

4 Environment

4.1 General

Min. permitted ambient temperature TU min.	-20 °C	
Max. permitted ambient temperature TU max.	75 °C	
Min. permitted storage temperature TL min.	-40 °C	
Max. permitted storage temperature TL max.	80 °C	

4.2 Climatic Requirements

IP-protection type (certified)	IP 68 (for fan only, not for connector if applicable) **)	
Humidity requirements	humid temperature, cyclic; according to DIN EN 60068-2-38, 10 cycle and condensation water check; according to DIN EN ISO 6270-2, 14 days	
Salt fog requirements	Salt fog, cyclic, in operation; according to DIN EN 60068-2-52; 10 cycles	

Permitted application area:

The product is for the use in open and unsheltered areas. Direct exposure to water as well as saline ambient conditions are allowed provided that this does not prevent the normal operation.

Pollution degree 4 (according DIN EN 60664-1)

It occurs permanent conductivity caused by conductive dust, rain or moisture.

**) The specification of the IP protection refers to the conditions mentioned in certification of the fan. The above mentioned short description of the protection scope is not final. For detailed information of the respective protection scope and definitions, see certification as well as DIN EN 60529 (protection by housings) and ISO 20653 (for vehicles) with the letter K.

Short description of the IP-protection type:

Solid particle Protection: Dust tight.

Protection against deliberate contact: Protected against contact to hazardous parts with a wire.

Protection against water: The fan test according to IP68 (Based on IEC 60529), is conducted in non-operating mode. The fan is tested by a complete immersion in water for a period of 2h at a water-level of 1,2m. Electrical connections are not immersed since they are customer specific.

4.3 Mechanical Requirements

severity level	Vibration (sinusoidal)	
1 G	Vibration (sinusoidal) in use IEC 60068-2-6 Displacement / frequency range Acceleration / frequency range Sweep rate Sweep cycles Duration Axes of vibration	Vibration (sinusoidal) 0,075 mm / 10-58, 58-10 Hz 1 G / 58-500-58 Hz 1 Oct./min 10 2 hrs. 3

severity level	stationary use		
1	storage / transportation	Random vibration not in use IEC 60068-2-64 Frequency range / ASD G _{RMS} Axes of vibration Test duration	Random vibration 5 - 20 Hz : 1,0 m ² / s ³ 20 - 500 Hz : - 3 dB / Oct 0,91 G 3 3 x 5 h
	storage / transportation	Bump not in use IEC 60068-2-29 Shock spectrum Acceleration Duration Number of bumps (+X, -X, -Y, +Y, -Z, +Z) Total bumps	Bump half sine 18 G 6 ms 100 in each direction 600
	stationary use	Random vibration in use IEC 60068-2-64 Frequency range / ASD G _{RMS} Axes of vibration Test duration	Random vibration 5 - 20 Hz : 2,0 m ² / s ³ 20- 150 Hz : - 3 dB / Oct 0,83 G 3 3 x 5 h
	stationary use	Bump in use IEC 60068-2-29 Shock spectrum Acceleration Duration Number of bumps (+X, -X, -Y, +Y, -Z, +Z) Total bumps	Bump half sine 5 G 11 ms 100 in each direction 600

5 Safety

5.1 Electrical Safety

Dielectric strength DIN EN 60950 (VDE 0805) and DIN EN 60335 (VDE 0700) A.) Type test Measuring conditions: After 48h of storage at 95% R.H. and 25°C. No arcing or breakdown is allowed! All connections together to ground.	500 VAC / 1 Min.	
B.) Routine test Measuring conditions: At indoor climate. No arcing or breakdown is allowed! All connections together to ground.	Not applicable	
Isolation resistance Measuring conditions: After 48h of storage at 95% R.H. and 25°C measured with U=500 VDC for 1 min.	RI > 10 MOhm	
Clearance / creepage distance	1,0 mm / 1,2 mm	
Protection class	III	

5.2 Approval Tests

CE	EC Declaration of Conformity	Yes
EAC	Eurasian Conformity	Yes
UL	Underwriters Laboratories	Yes / UL507, Electric Fans E38324
VDE	Association for Electrical, Electronic and Information Technologies	Yes / Approval acc. to EN 62368 - Audio/video, information and communication technology equipment
CSA	Canadian Standards Association	Yes / C22.2 No. 113 Fans and Ventilators
CCC	China Compulsory Certification	Not applicable

6 Reliability

6.1 General

Life expectancy L10 at TU = 40 °C	60.000 h	
Life expectancy L10 at TU max.	20.000 h	
Life expectancy L10 acc. to IPC 9591 at TU = 40 °C	102.500 h	

Copying of this document, and giving it others and the use or communication of the contents thereof, are forbidden without express authority. Offenders are liable to the payment of damages. All rights are reserved in the event of the grant of a patent or the registration of a utility model or design.

Schutzvermerk nach DIN ISO 16016 beachten!
Refer to protection notice DIN ISO 16016!

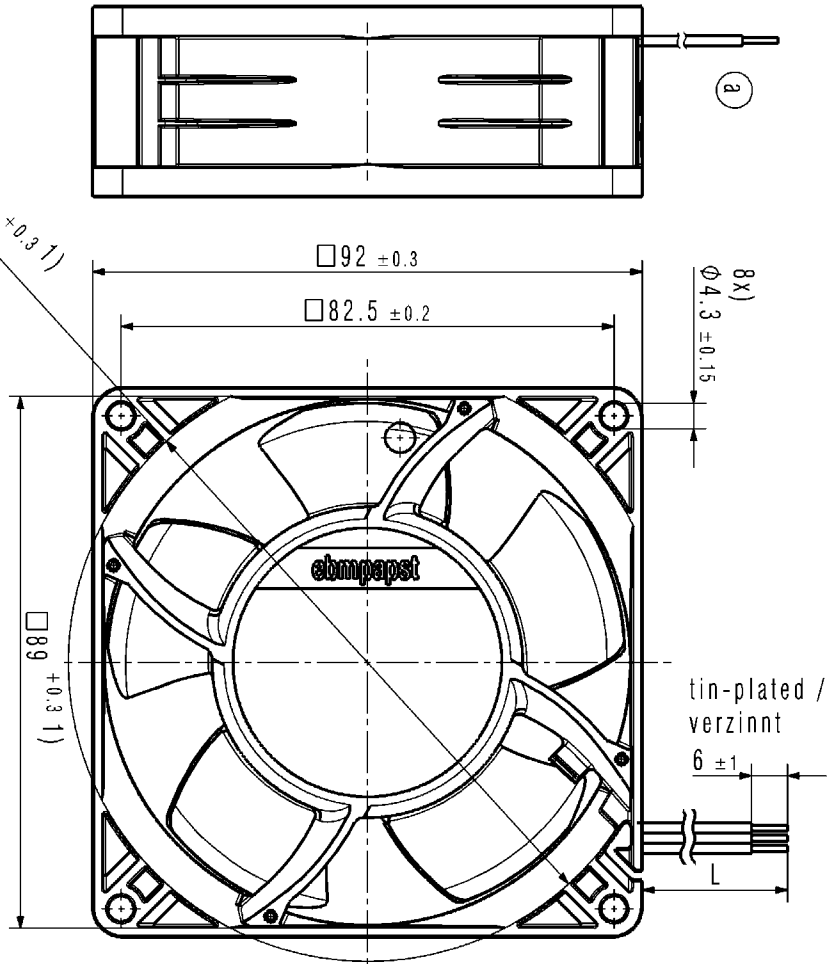

- 1) Maße für Montagewand / Dimensions for assembly wall
- Kein Axialspiel der Kugellager durch Federausgleich / no axial clearance of ball bearings due to a pre-load spring
 - Anzahl und Länge der Litzen siehe Produktspezifikation Blatt 1
 - Number and length of the wires see design specification sheet 1

SAP-Status/State Art.-Nr. / Change-No.	CAD-System-Version/ CAD-System-Version 929351014	CAD-Umgebung/ CAD-Environment	Hersteller / Material: Volumen / Volume (m ³):
	3D-Referenzmodell / 3D Reference Model 3D-Referenzmodell / 3D Reference Model	Datum Name	Artikel / Title: Gewicht / Mass (kg):
Tolerierung / Tolerances: Allgemeintoleranzen / Gen. Tolerances:	Bearb. / Drawn Gepr. / Checked Freig. / Released	Zeich.-Nr. / Drawing No.:	Efs. / Zeichn. / Partclass:
sdb-ebmpast St. Georgen GmbH & Co. KG	ebmpapst	Dokumenttyp / Type of Document Teilenummer (Blatt/ Page) Index / Index	Format / Size: Massstab/Scale