

Product Data Sheet 3214 J/2H3PR-204

ebmpapst

The engineer's choice

3214J/2H3PR-204 ebmpapst Datasheet FansCo
sales@fansco.com
www.fansco.com



3214 J/2H3PR-204

INDEX

1	General	3
2	Mechanics	3
2.1	General	3
2.2	Connections	3
3	Operating Data	4
3.1	Electrical Interface - Input	4
3.2	Electrical Operating Data	5
3.3	Electrical Interface - Output - Tacho	6
3.4	Electrical Features	7
3.5	Aerodynamics	8
3.6	Sound Data	9
4	Environment.....	9
4.1	General	9
4.2	Climatic Requirements.....	9
5	Safety	10
5.1	Electrical Safety	10
5.2	Approval Tests	10
6	Reliability.....	10
6.1	General	10

1 General

Fan type	Fan	
Rotating direction looking at rotor	Clockwise	
Airflow direction	Air outlet over struts	
Bearing system	Ball bearing	
Mounting position - shaft	Any	

2 Mechanics

2.1 General

Width	92,0 mm	
Height	92,0 mm	
Depth	38,0 mm	
Mass	0,290 kg	
Housing material	Plastic	
Impeller material	Plastic	
Max. torque when mounted across both mounting flanges	Wire outlet corner: 30 Ncm Remaining corners: 30 Ncm	
Screw size	ISO 4762 - M4 degreased, without an additional brace and without washer	

2.2 Connections

Electrical connection	Wires	
Lead wire length	L = 180 mm	
Tolerance	+/- 10 mm	
Wire size (AWG)	22	
Insulation diameter	1,30 mm	

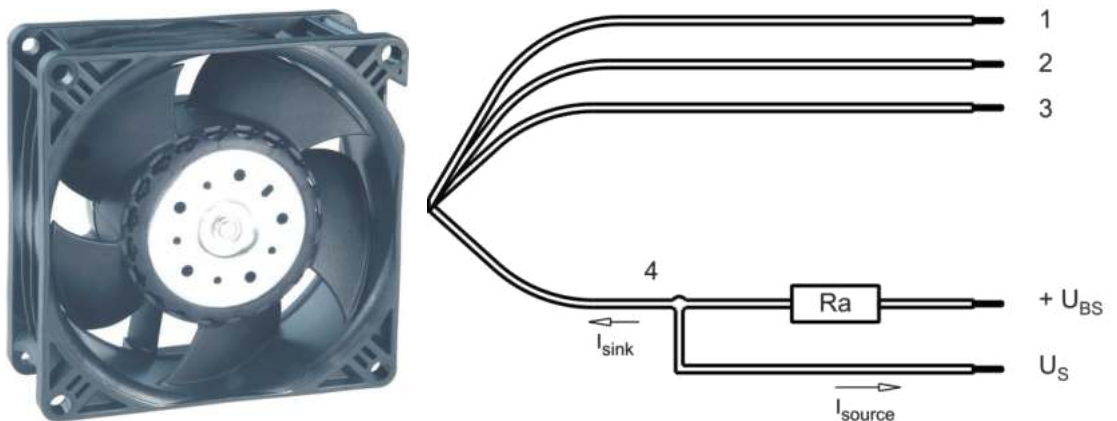

Wire	Color	Operation
1	red	+ UB
2	blue	- GND
3	violet	PWM
4	white	Tacho

The auxiliaries shown on the schematic diagram (which are required for the intended use) are not part of our delivery.

3 Operating Data

3.1 Electrical Interface - Input

Control input	PWM
---------------	-----

Features

Input type	Open collector	
PWM - Frequency		1 kHz - 30 kHz typical: 5 kHz

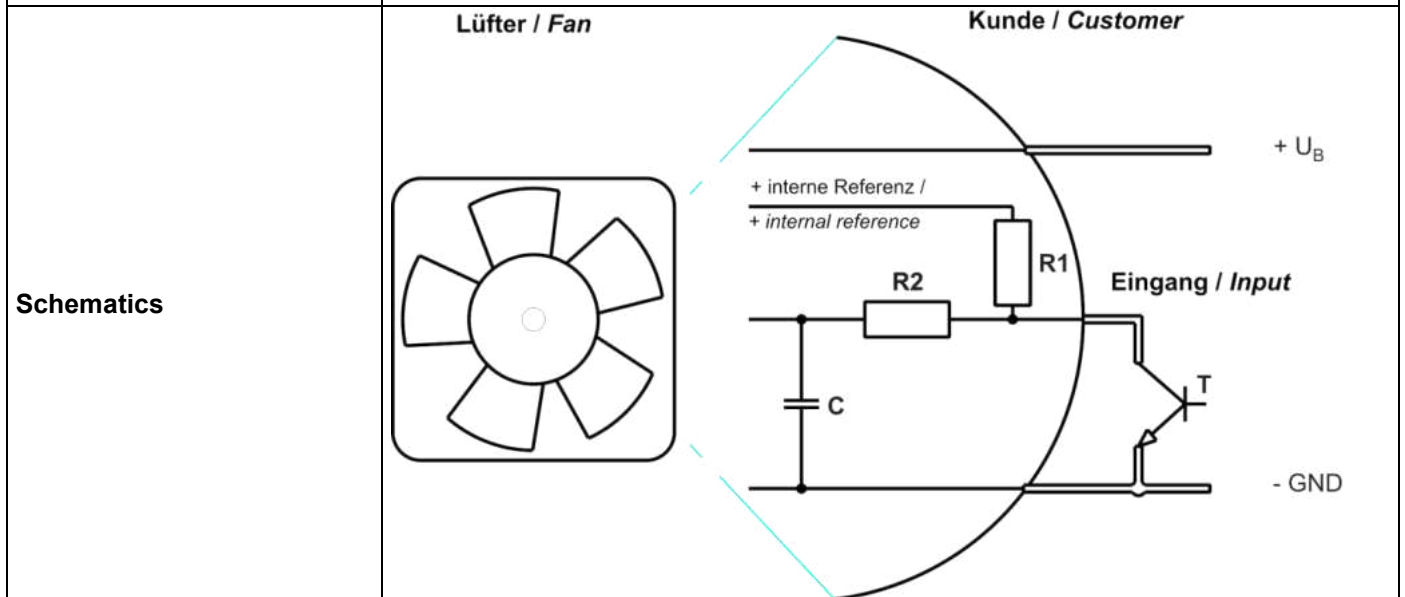
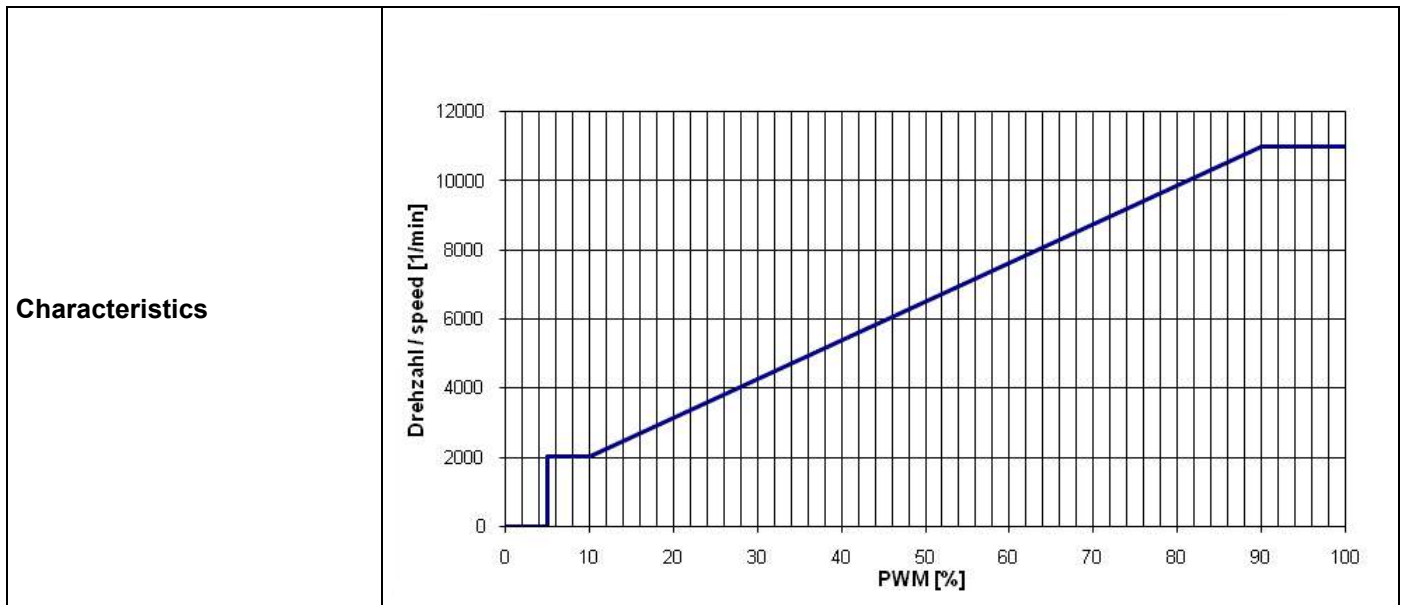

3.2 Electrical Operating Data

Measurement conditions: Normal air density = 1,2 kg/m³; Temperature 23°C +/- 3°C; Motor axis horizontal; warm-up time before measuring 5 minutes (unless otherwise specified). In the intake and outlet area should not be any solid obstruction within 0,5 m.

$\Delta p = 0$: corresp. to free air flow (see section 3.5)

I: corresp. to arithm. mean current value

Name	Condition		
PWM 0001	PWM: 100 %; f: 5 kHz	f: 1 kHz	f: 30 kHz

Features	Condition	Symbol	Values		
Voltage range		U	12 V		27,6 V
Nominal voltage		U_N		24 V	
Power consumption	$\Delta p = 0$	P	6,8 W	30 W	31,2 W
Tolerance	PWM 0010		+/- 17,5 %	+/- 25 %	+/- 25 %
Current consumption	$\Delta p = 0$	I	570 mA	1.240 mA	1.130 mA
Tolerance	PWM 0010		+/- 17,5 %	+/- 25 %	+/- 25 %
Speed	$\Delta p = 0$	n	6.380 1/min	11.000 1/min	11.000 1/min
Tolerance	PWM 0010		+/- 12,5 %	+/- 3 %	+/- 3 %
Starting current consumption				4.800 mA	

3.3 Electrical Interface - Output - Tacho

Tacho type	/2 (open collector)
------------	---------------------

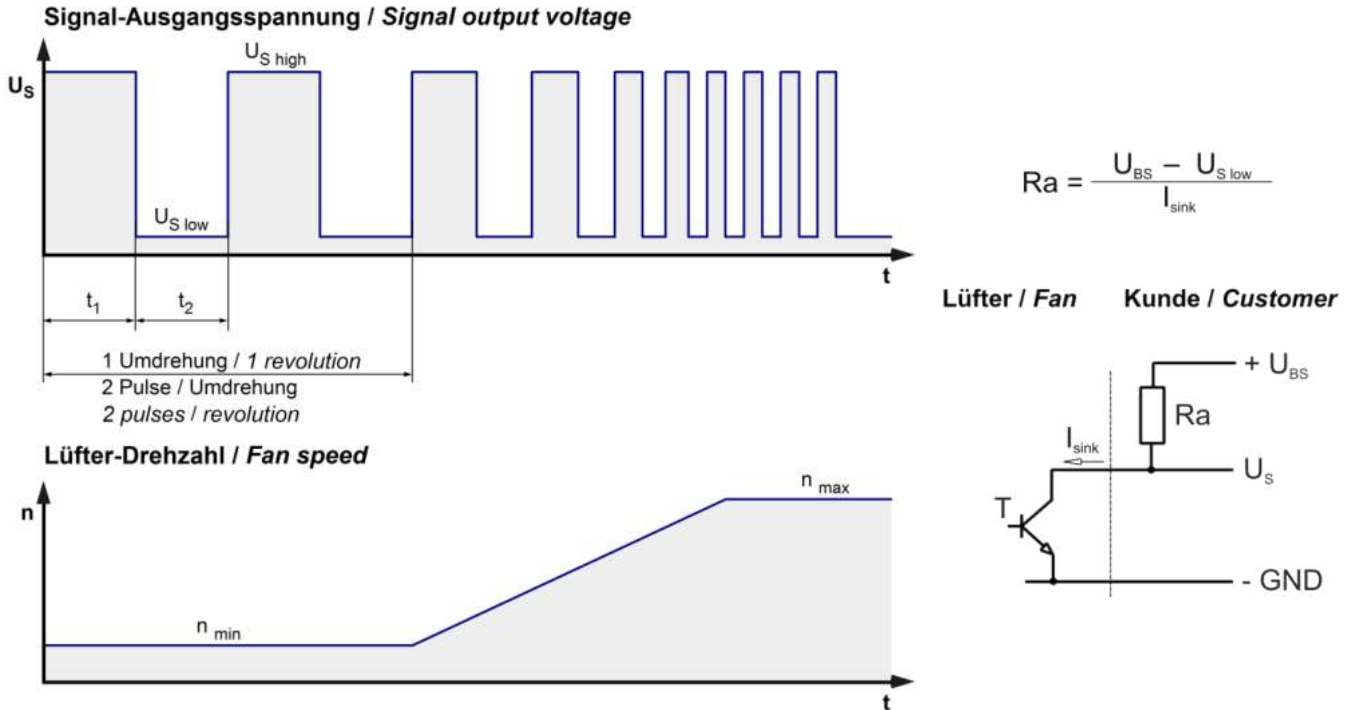

Features	Note	Values
Tacho operating voltage	U_{BS}	$\leq 60,0\ V$
Tacho signal Low	$U_{S\ low}$	$\leq 0,4\ V$
Tacho signal High	$U_{S\ high}$	$60,0\ V$
Maximum sink current	I_{sink}	$\leq 4\ mA$
External resistor	External resistor Ra from UBS to US required. All voltages measured to GND.	
Tacho frequency	$(2 \times n) / 60$	
Tacho isolated from motor	No	
Slew rate		$\Rightarrow 0,5\ V/us$

n = revolutions per minute (1/min)

3.4 Electrical Features

Electronic function	Speed-Controlled	
Reversed polarity protection	Rectifying diode	
Max. residual current at U_N	$I_F \leq 300 \mu\text{A}$	
Locked rotor protection	Auto restart	
Locked rotor current at U_N	I_{block} approx. 4.300 mA	
Clock signal at locked rotor	t_3 / t_4 typical: 0,5 s / 10,0 s	

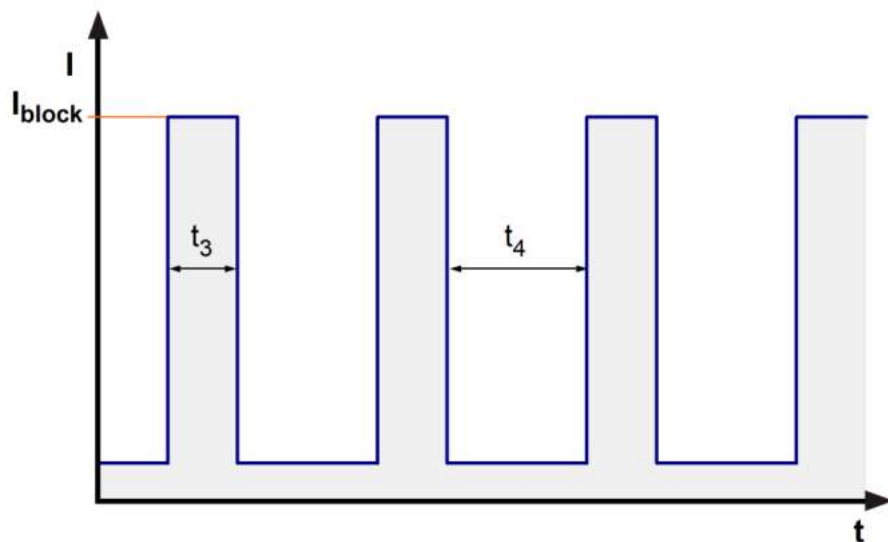

3.5 Aerodynamics

Measurement conditions: Measured with a double chamber intake rig acc. to DIN EN ISO 5801. Normal air density = 1,2 kg/m³; Temperature 23°C +/- 3°C; In the intake and outlet area should not be any solid obstruction within 0,5 m. The information is only valid under the specified test conditions and may be changed by the installation conditions. If there are deviations from the standard test conditions, the characteristic values must be checked under the installed conditions.

a.) Operation condition:

11.000 1/min at free air flow	PWM 100 %; f: 5 kHz	f: 1 kHz	f: 30 kHz
-------------------------------	---------------------	----------	-----------

Max. free-air flow ($\Delta p = 0 / \dot{V} = \max.$)	238,0 m ³ /h	
Max. static pressure ($\Delta p = \max. / \dot{V} = 0$)	645 Pa	

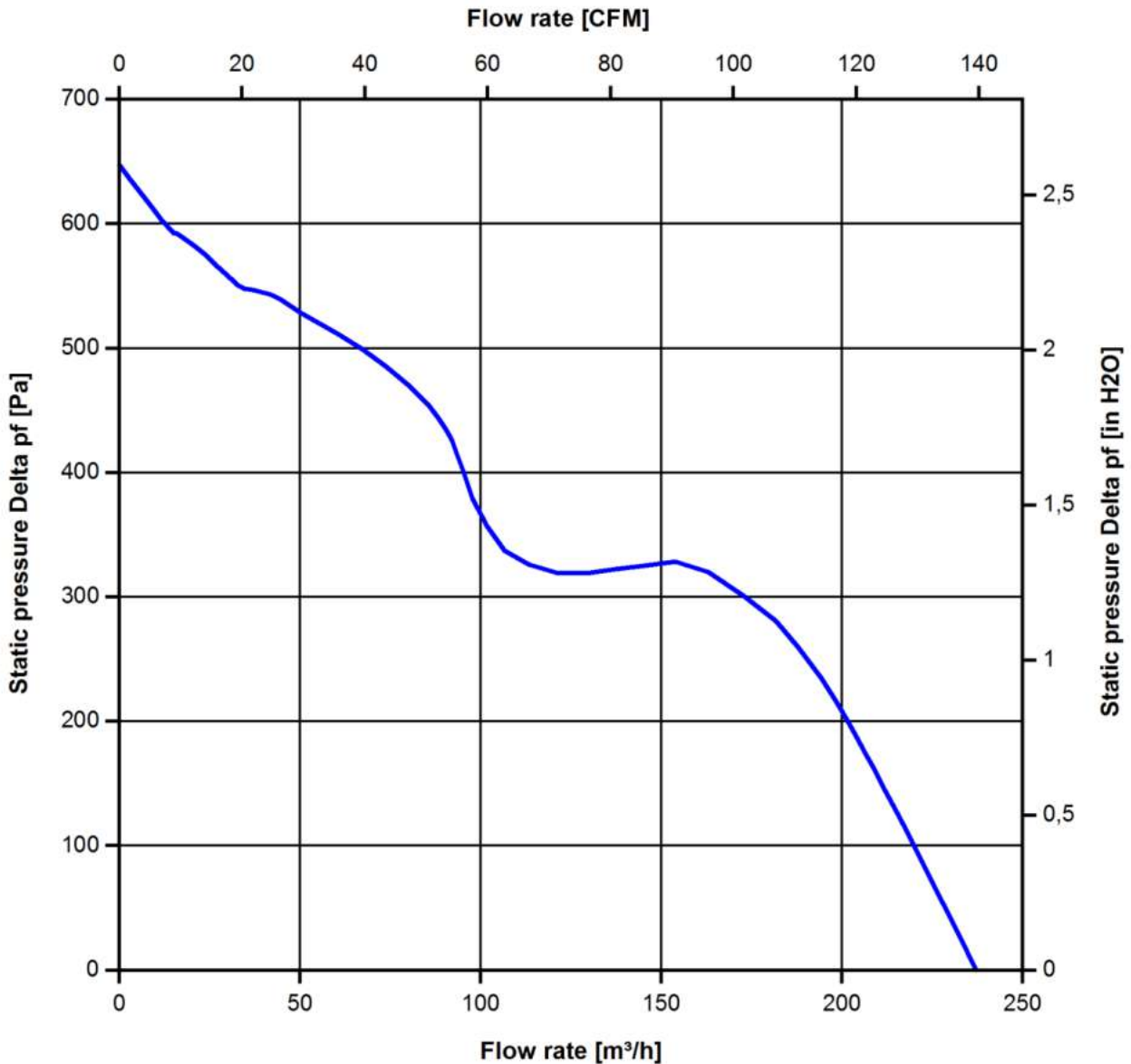

3.6 Sound Data

Measurement conditions: Sound pressure level: 1 meter distance between microphone and the air intake.
 Sound power level: Acc. to DIN 45635 part 38 (ISO 10302)
 Measured in a semianchoic chamber with a background noise level of $L_p(A) < 5 \text{ dB(A)}$
 For further measurement conditions see section 3.5

a.) Operation condition:

11.000 1/min at free air flow	PWM 100 %; f: 5 kHz	PWM min.: ; f: 1 kHz	PWM max.:; f: 30 kHz
-------------------------------	---------------------	----------------------	----------------------

Optimal operating point	170,0 m ³ /h @ 300 Pa	
Sound power level at the optimal operating point	7,8 bel(A)	
Sound pressure level at free air flow, measured in rubber bands	69,0 dB(A)	

4 Environment

4.1 General

Min. permitted ambient temperature TU min.	-20 °C	
Max. permitted ambient temperature TU max.	70 °C	
Min. permitted storage temperature TL min.	-40 °C	
Max. permitted storage temperature TL max.	80 °C	

4.2 Climatic Requirements

Humidity requirements	humid heat, cyclic; according to DIN EN 60068-2-30, 6 cycle	
Water exposure	None	
Dust requirements	Dust check; according to DIN EN 60068-2-68, 6g/m ² d, 1 day	
Salt fog requirements	None	

Permitted application area:

The product is for the use in sheltered rooms with limited controlled temperature. Occasionally condensed water is allowed. Direct exposure to water must be avoided. Saline ambient conditions must be avoided.

Pollution degree 2 (according DIN EN 60664-1)

It occurs only non-conductive pollution. Occassionally, temporary conductivity caused by condensation occurs.

Please require severity levels and specification parameters from the responsible development departments.

5 Safety

5.1 Electrical Safety

Dielectric strength DIN EN 60950 (VDE 0805) and DIN EN 60335 (VDE 0700) A.) Type test Measuring conditions: After 48h of storage at 95% R.H. and 25°C. No arcing or breakdown is allowed! All connections together to ground.	500 VAC / 1 Min.	
B.) Routine test Measuring conditions: At indoor climate. No arcing or breakdown is allowed! All connections together to ground.	500 VAC / 1 Sec.	
Isolation resistance Measuring conditions: After 48h of storage at 95% R.H. and 25°C measured with U=500 VDC for 1 min.	RI > 10 MOhm	
Clearance / creepage distance	1,0 mm / 1,2 mm	
Protection class	III	

5.2 Approval Tests

CE	EC Declaration of Conformity	Yes
EAC	Eurasian Conformity	Yes
UL	Underwriters Laboratories	Yes / UL507, Electric Fans
VDE	Association for Electrical, Electronic and Information Technologies	Yes / Approval acc. to EN 60950 (VDE 0805) - Information technology equipment
CSA	Canadian Standards Association	Yes / C22.2 No. 113 Fans and Ventilators
CCC	China Compulsory Certification	Not applicable

6 Reliability

6.1 General

Life expectancy L10 at TU = 40 °C	65.000 h	
Life expectancy L10 at TU max.	32.500 h	
Life expectancy L10 acc. to IPC 9591 at TU = 40 °C	110.000 h	

Figure 1: The drawing, and data, in every detail are the result of communication of the product design, and
 therefore, unless expressly indicated, they are the property of FansCo. All rights are reserved.
 In the event of a patent or other registration of a similar model or design.

5th. version and 2012.03.09. version 1
 for a previous version of the drawing

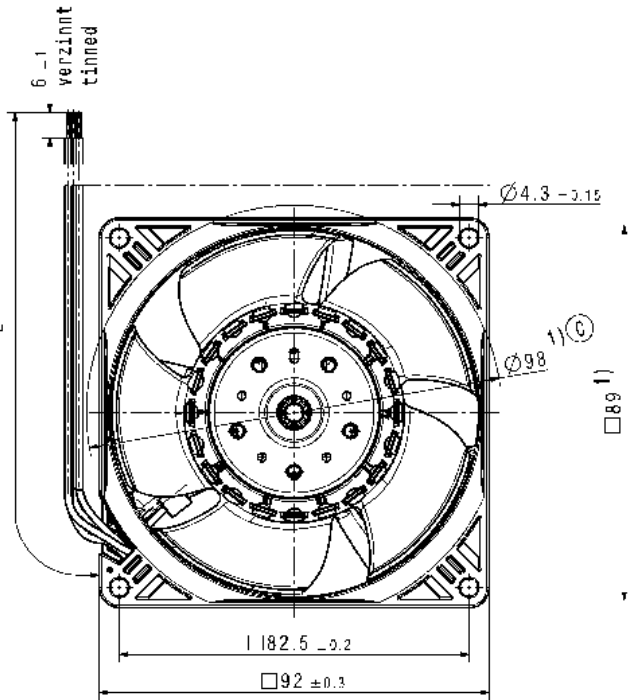

Vorderansicht
 Maßstab: 1:1
 front view
 scale: 1:1

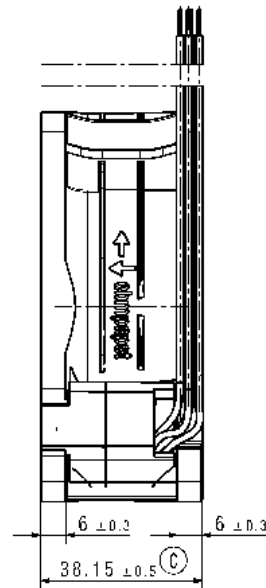

Seitenansicht links
 Maßstab: 1:1
 side view left
 scale: 1:1

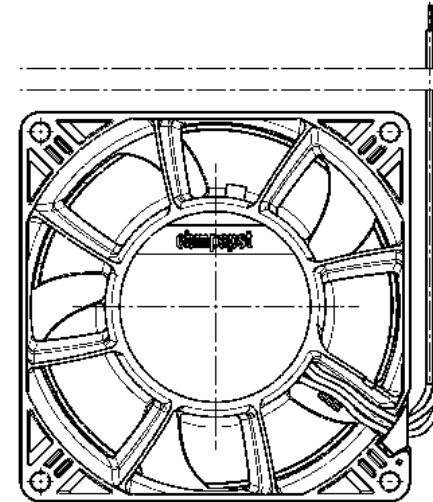

Rückansicht
 Maßstab: 1:1
 back view
 scale: 1:1

Zeichnung entspricht 3D-Modell:
 Drawing is equivalent to 3D-Model:
 9699520181_CPR_000_C
 System: CATIA V5 R 14

1) Maße für Montagewand
 1) dimension for worktop mounting

-Anzahl und Länge der Litzen siehe Produktspezifikation
 number and length of the wires, look at the product specification

-Kein Axialspiel bei Kugellager durch Federausgleich
 no axial clearance of ball bearings conditional on a pre-load spring

3D-Modell / 3D-Modell 3D-Modell / 3D-Modell		3D-Modell / 3D-Modell 3D-Modell / 3D-Modell		3D-Modell / 3D-Modell 3D-Modell / 3D-Modell	
3D-Modell / 3D-Modell 3D-Modell / 3D-Modell		3D-Modell / 3D-Modell 3D-Modell / 3D-Modell		3D-Modell / 3D-Modell 3D-Modell / 3D-Modell	
3D-Modell / 3D-Modell 3D-Modell / 3D-Modell		3D-Modell / 3D-Modell 3D-Modell / 3D-Modell		3D-Modell / 3D-Modell 3D-Modell / 3D-Modell	
3D-Modell / 3D-Modell 3D-Modell / 3D-Modell		3D-Modell / 3D-Modell 3D-Modell / 3D-Modell		3D-Modell / 3D-Modell 3D-Modell / 3D-Modell	
3D-Modell / 3D-Modell 3D-Modell / 3D-Modell		3D-Modell / 3D-Modell 3D-Modell / 3D-Modell		3D-Modell / 3D-Modell 3D-Modell / 3D-Modell	