

Product Data Sheet **9295420200**
VWLG200FKLVS
2218 F/2TDH4P

2218F/2TDH4P (9295420200) ebmpapst Datasheet
sales@fansco.com www.fansco.com

ebmpapst

engineering a better life



2218 F/2TDH4P

INDEX

1 General 3

2 Mechanics 3

2.1 General 3

2.2 Connections 3

3 Operating Data 5

3.1 Electrical Interface - Input 5

3.2 Electrical Operating Data 6

3.3 Electrical Interface - Output 7

3.4 Electrical Features 8

3.5 Data According ErP Directive 8

3.6 Aerodynamics 9

3.7 Sound Data 10

4 Environment 10

4.1 General 10

4.2 Climatic Requirements 11

4.3 Mechanical Requirements 12

5 Safety 14

5.1 Electrical Safety 14

5.2 Approval Tests 14

6 Reliability 14

6.1 General 14

1 General

Fan type	Axial-Panel-Fan	
Rotating direction looking at rotor	Counterclockwise	
Airflow direction	Air outlet over struts	
Bearing system	Ball bearing	
Mounting position - shaft	Any	

2 Mechanics**2.1 General**

Width	200 mm	
Height	200 mm	
Depth	51 mm	
Diameter	220 mm	
Mass	1,06 kg	
Housing material	Metal	
Impeller material	Plastic	

2.2 Connections

Electrical connection	Wires	
Lead wire length	L = 400 mm	
Tolerance	+/- 10 mm	
Tube length	S = 10 mm	
Tolerance	+/- 2,0 mm	

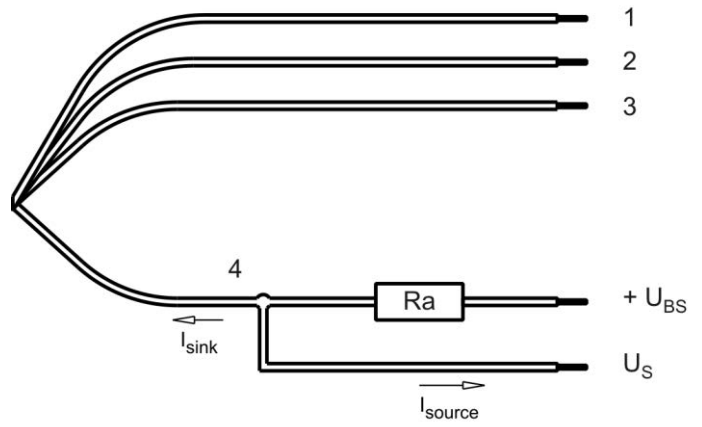

Wire	Color	Operation	Wire size	Insulation diameter
1	red	+ UB	AWG 20	1,95 mm
2	blue	- GND	AWG 20	1,95 mm
3	violet	PWM	AWG 22	1,3 mm
4	white	Tacho	AWG 22	1,3 mm

The auxiliaries shown on the schematic diagram (which are required for the intended use) are not part of our delivery.

3 Operating Data

3.1 Electrical Interface - Input

Control input	PWM
---------------	-----

Features

Input type	Open collector	
PWM - Frequency		1 kHz - 10 kHz typical: 2 kHz

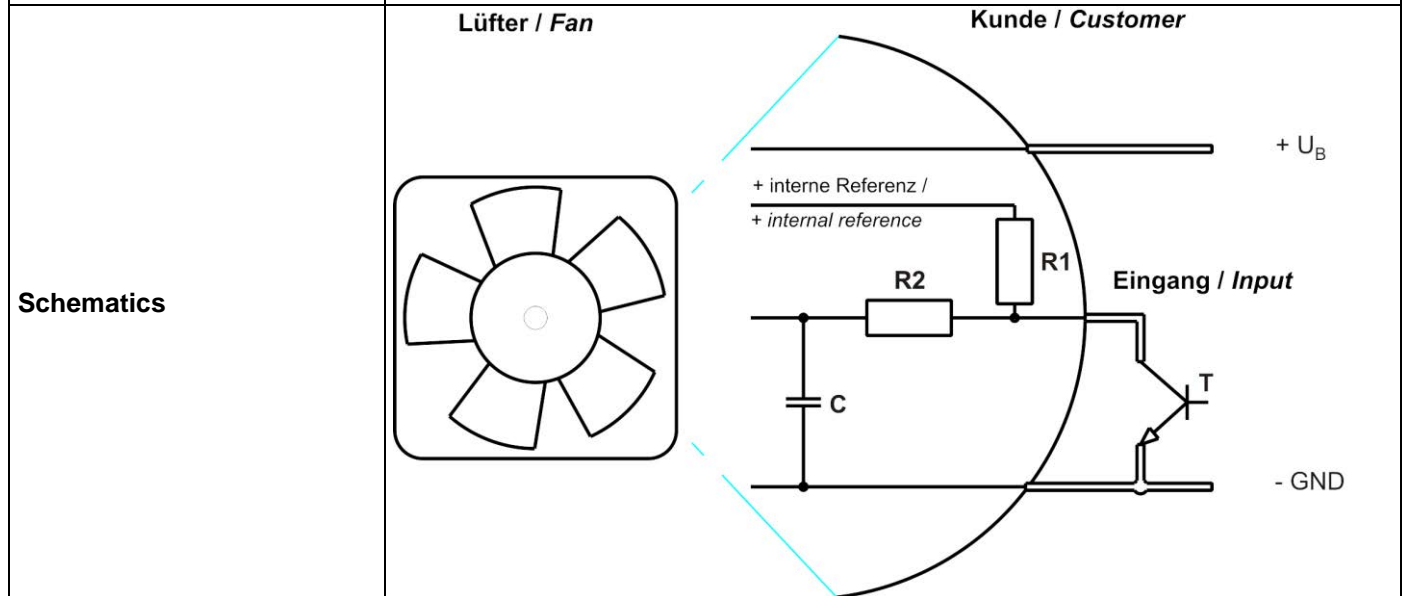
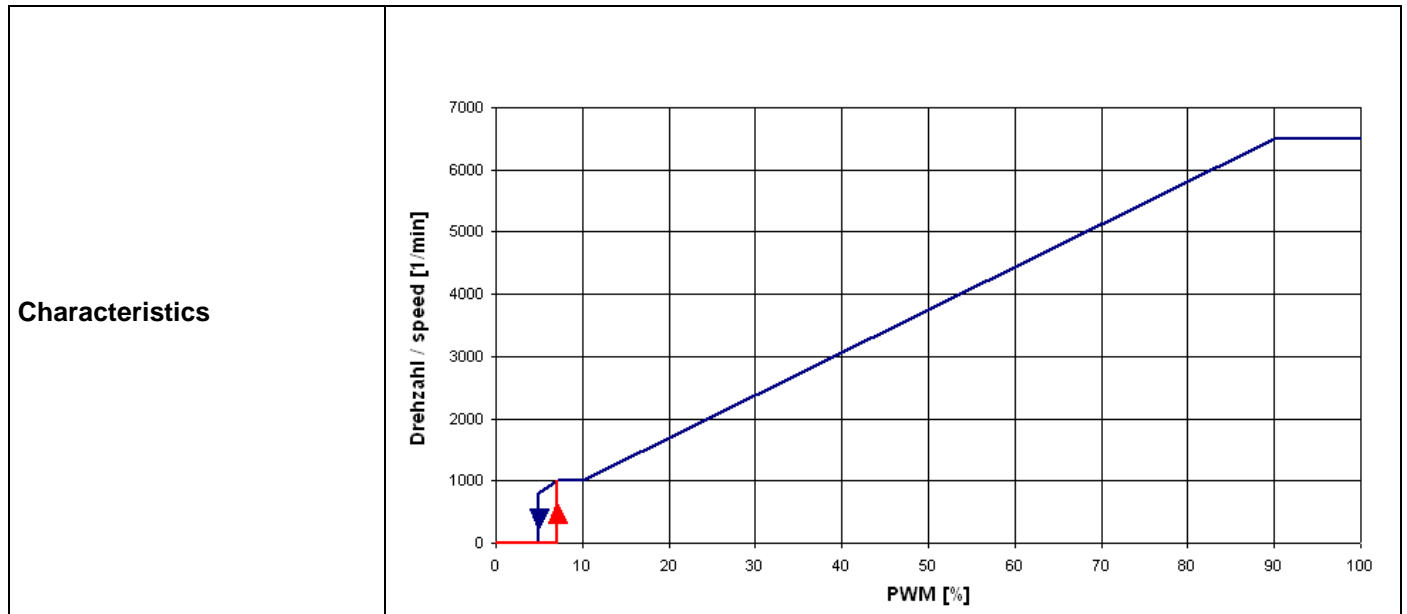

The shown pull-up resistor R1 to the internal reference voltage (+5V) has 4.7kOhm.

Transistor requirements:

Vce max. >= 12V ; Isink max. >= 5mA ; Vce sat. <= 0,15V

Information to the curve:

0 % - <7% PWM:	0 1/min
7 % PWM:	1.000 1/min (Fan on, comming from 0% PWM)
7 % - 10% PWM:	1.000 1/min (corresponding to min. speed)
10 % - 90% PWM:	linear increasing curve
90 % - 100% PWM:	6.500 1/min (corresponding to max. speed)
7 % - >5 % PWM:	linear decreasing curve (comming from 100% PWM)
5 % PWM:	800 1/min or 0 1/min (Fan off, comming from 100% PWM)

3.2 Electrical Operating Data

Measurement conditions: Normal air density = 1,2 kg/m³; Temperature 23°C +/- 3°C; Motor axis horizontal; warm-up time before measuring 5 minutes (unless otherwise specified). In the intake and outlet area should not be any solid obstruction within 0,5 m.

$\Delta p = 0$: corresp. to free air flow (see chapter aerodynamics)
I: corresp. to arithm. mean current value

Name	Condition
PWM 0001	PWM: 100 %; f: 2 kHz

Features	Condition	Symbol	Values		
Voltage range		U	36 V		72 V
Nominal voltage		U _N		48 V	
Power consumption	$\Delta p = 0$	P	81 W	103 W	108 W
Tolerance	PWM 0010		+/- 12 %	+/- 10 %	+/- 10 %
Current consumption	$\Delta p = 0$	I	2.250 mA	2.150 mA	1.500 mA
Tolerance	PWM 0010		+/- 12 %	+/- 10 %	+/- 10 %
Speed	$\Delta p = 0$	n	6.000 1/min	6.500 1/min	6.500 1/min
Tolerance	PWM 0010		+/- 5 %	+/- 3 %	+/- 3 %

3.3 Electrical Interface - Output

Tacho type	/2 (open collector)
------------	---------------------

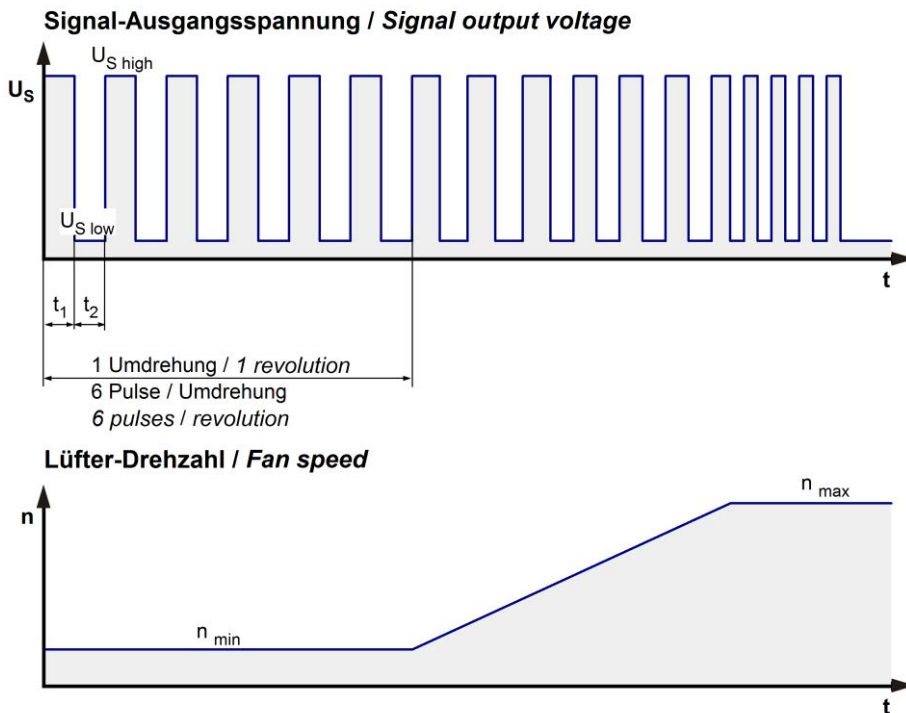

$$R_a = \frac{U_{BS} - U_{S\ low}}{I_{sink}}$$

Lüfter / Fan Kunde / Customer

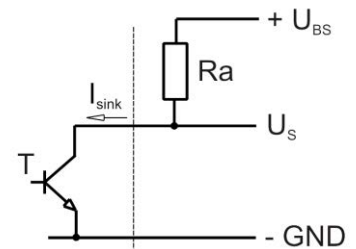

Features	Note	Values
Tacho operating voltage	U_{BS}	$\leq 60\ V$
Tacho signal Low	$U_{S\ low}$	$\leq 0,4\ V$
Tacho signal High	$U_{S\ high}$	$\leq 60\ V$
Maximum sink current	I_{sink}	20 mA
External resistor	External resistor R_a from U_{BS} to U_S required. All voltages measured to GND.	
Tacho frequency	$(6 \times n) / 60$	650 Hz @ 6.500 1/min
Tacho isolated from motor	No	
Slew rate		$\geq 0,5\ V/\mu s$

n = revolutions per minute (1/min)

3.4 Electrical Features

Electronic function	Speed-Controlled	
Reversed polarity protection	P-CH FET	
Max. residual current at U_N	$I_F \leq 5 \text{ mA}$	
Locked rotor protection	Auto restart	
Locked rotor current at U_N	I_{block} approx. 2.000 mA	
Clock signal at locked rotor	t_3 / t_4 typical: 3,0 s / 10,0 s	
Internal fuse	Littelfuse NANO2 > Very Fast-Acting > 451/453 Series 10A / 125V (Art.No.: 0451010.MRL)	
Voltage control *)	Fan turns on at $U_B > 34 \text{ V}$ or $< 78 \text{ V}$ Fan turns off at $U_B < 32 \text{ V}$ or $> 80 \text{ V}$	

*) This fan has an undervoltage and overvoltage control circuit integrated which turns the motor off if the voltage is out of range.

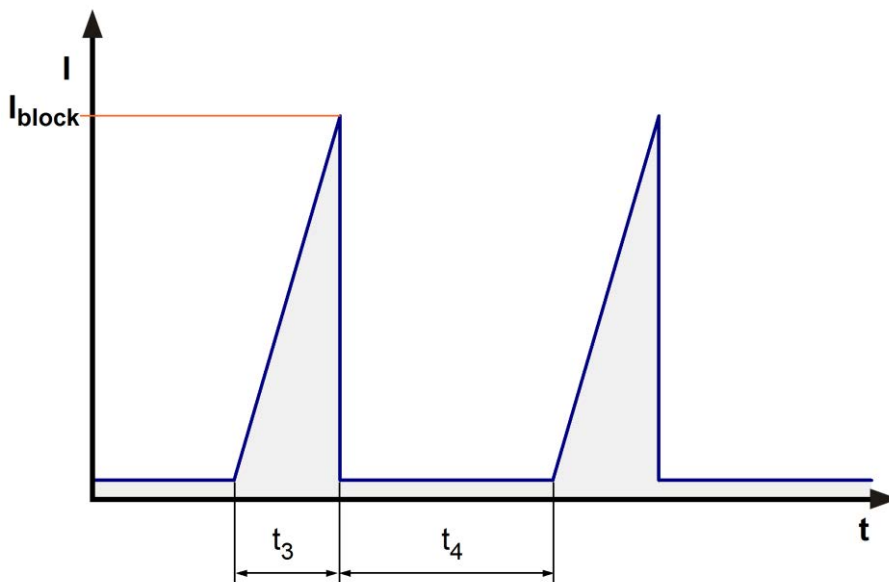

This fan has a startup delay of 2 seconds after applying supply voltage.

3.5 Data According ErP Directive

Installation / Efficiency category	A / static
Speed control	integrated
Specific ratio	1,00361
Target overall efficiency 2015	29,0 %
Overall efficiency	53,6 %
Efficiency grade	40
Power input	179 W
Speed	6.476 1/min

All values measured in optimum energy efficiency point.

Productiondatecode is printed on the fan label.

3.6 Aerodynamics

Measurement conditions:

Measured with a double chamber intake rig acc. to DIN EN ISO 5801.
 Normal air density = 1,2 kg/m³; Temperature 23°C +/- 3°C;
 In the intake and outlet area should not be any solid obstruction within 0,5 m. Motor shaft horizontal.
 The information is only valid under the specified test conditions and may be changed by the installation conditions. If there are deviations from the standard test conditions, the characteristic values must be checked under the installed conditions. Power consumption of the fan motor when operating at normal voltage is shown. Depending on the operating conditions of the application, the power input may be higher.

a.) Operation condition:

6.500 1/min at free air flow	PWM 100 %; f: 2 kHz		
------------------------------	---------------------	--	--

Max. free-air flow ($\Delta p = 0 / \dot{V} = \text{max.}$)	1.220 m ³ /h	
Max. static pressure ($\Delta p = \text{max.} / \dot{V} = 0$)	1.170 Pa	

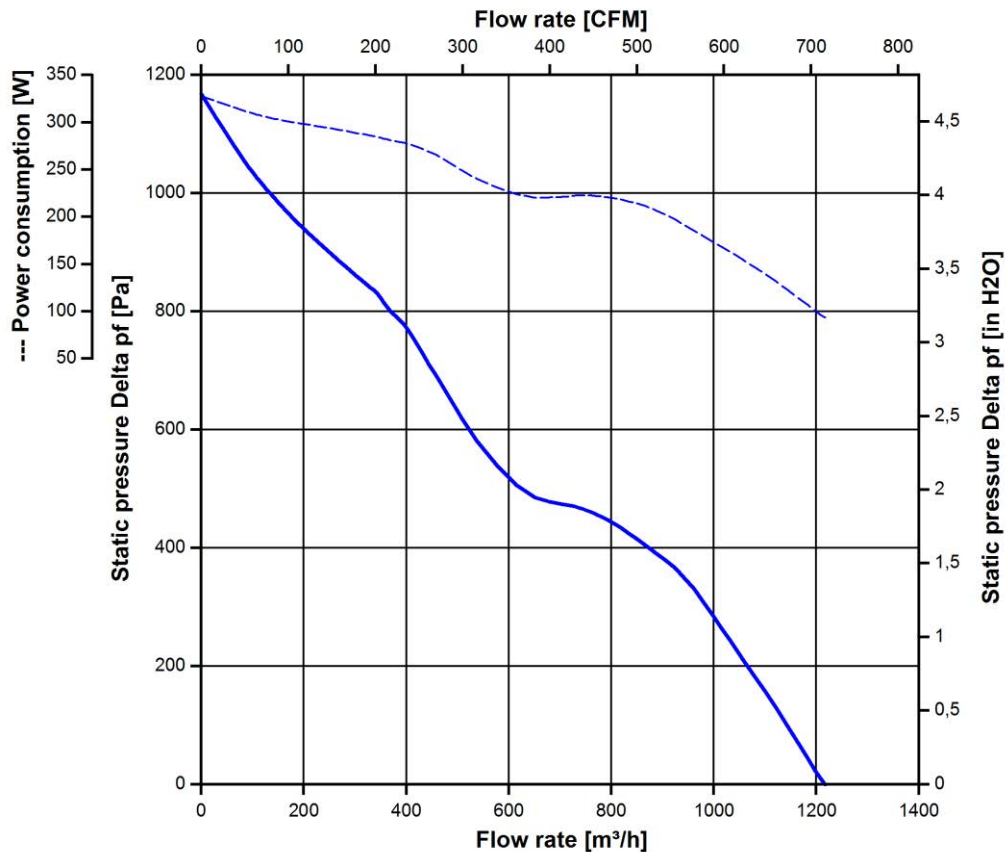

3.7 Sound Data

Measurement conditions: Sound pressure level: 1 meter distance between microphone and the air intake.
 Sound power level: Acc. to DIN 45635 part 38 (ISO 10302)
 Measured in a semianechoic chamber with a background noise level of $L_p(A) < 5 \text{ dB(A)}$
 For further measurement conditions see chapter aerodynamics.

a.) Operation condition:

6.500 1/min at free air flow	PWM 100 %; f: 2 kHz		
------------------------------	---------------------	--	--

Optimal operating point	1.200 m ³ /h @ 44 Pa		
Sound power level at the optimal operating point	8,2 bel(A)		
Sound pressure level at free air flow, measured in rubber bands	74,0 dB(A)		

4 Environment

4.1 General

Min. permitted ambient temperature TU min.	-20 °C		
Max. permitted ambient temperature TU max.	65 °C		
Min. permitted storage temperature TL min.	-40 °C		
Max. permitted storage temperature TL max.	80 °C		

4.2 Climatic Requirements

IP-protection type (certified)	IP 00 **)	
Humidity requirements	humid heat, constant; according to DIN EN 60068-2-78, 14 days	
Salt fog requirements	None	

Permitted application area:

The product is intended for use in sheltered rooms with controlled temperature and controlled humidity. Directly exposure to water must be avoided.

Pollution degree 1 (according DIN EN 60664-1)

There is either no pollution or it occurs only dry, non-conductive pollution. The pollution has no negative impact.

**) The specification of the IP protection refers to the conditions mentioned in certification of the fan. The above mentioned short description of the protection scope is not final. For detailed information of the respective protection scope and definitions, see certification as well as DIN EN 60529 (protection by housings) and ISO 20653 (for vehicles) with the letter K.

Short description of the IP-protection type:

- Solid particle Protection: No protection.
- Protection against deliberate contact: No protection.
- Protection against water: No protection.

4.3 Mechanical Requirements

severity level	Vibration (sinusoidal)	
2 G	Vibration (sinusoidal) in use IEC 60068-2-6 Displacement / frequency range Acceleration / frequency range Sweep rate Sweep cycles Duration Axes of vibration	Vibration (sinusoidal) 0,15 mm / 10-58, 58-10 Hz 2 G / 58-500-58 Hz 1 Oct./min 10 2 hrs. 3

severity level	stationary use		
1	storage / transportation	Random vibration not in use IEC 60068-2-64 Frequency range / ASD G _{RMS} Axes of vibration Test duration	Random vibration 5 - 20 Hz : 1,0 m ² / s ³ 20 - 500 Hz : - 3 dB / Oct 0,91 G 3 3 x 5 h
	storage / transportation	Bump not in use IEC 60068-2-29 Shock spectrum Acceleration Duration Number of bumps (+X, -X, -Y, +Y, -Z, +Z) Total bumps	Bump half sine 18 G 6 ms 100 in each direction 600
	stationary use	Random vibration in use IEC 60068-2-64 Frequency range / ASD G _{RMS} Axes of vibration Test duration	Random vibration 5 - 20 Hz : 2,0 m ² / s ³ 20- 150 Hz : - 3 dB / Oct 0,83 G 3 3 x 5 h
	stationary use	Bump in use IEC 60068-2-29 Shock spectrum Acceleration Duration Number of bumps (+X, -X, -Y, +Y, -Z, +Z) Total bumps	Bump half sine 5 G 11 ms 100 in each direction 600

severity level	Railroad application	
1 IEC 61373 Category 1	Random vibration in use IEC 60068-2-64 Frequency range / ASD	Random vibration 5 - 20 Hz : 2,0 m ² / s ³

Class B	GRMS Axes of vibration Test duration	20- 150 Hz : - 3 dB / Oct 0,83 G 3 3 x 5 h
	Shock in use IEC 60068-2-27 Shock spectrum Acceleration Duration Number of bumps (+X, -X, -Y, +Y, -Z, +Z) Total bumps	Shock half sine 7 G 18 ms 10 in each direction 60

5 Safety**5.1 Electrical Safety**

Dielectric strength DIN EN 62368 and DIN EN 60335 A.) Type test Measuring conditions: After 48h of storage at 95% R.H. and 25°C. No arcing or breakdown is allowed! All connections together to ground. B.) Routine test Measuring conditions: At indoor climate. No arcing or breakdown is allowed! All connections together to ground.	1000 VAC / 1 Min. 1700 VDC / 1 Sec.	
Isolation resistance Measuring conditions: After 48h of storage at 95% R.H. and 25°C measured with U=500 VDC for 1 min.	RI > 10 MOhm	
Clearance / creepage distance	1,0 mm / 1,5 mm	
Protection class	I	

5.2 Approval Tests

CE	EC Declaration of Conformity	No
UKCA	UK Conformity Assessed	Not applicable
EAC	Eurasian Conformity	Yes
America	UL - Underwriters Laboratories	Yes / UL audited by CSA according to UL507, Electric Fans
Europe	VDE - Association for Electrical or UL - Underwriters Laboratories or comparable	Yes / Approval acc. to EN 62368 - Audio/video, information and communication technology equipment
Canada	UL - Underwriters Laboratories or CSA - Canadian Standards Association	Yes / C22.2 No. 113 Fans and Ventilators
China	CCC - China Compulsory Certification or CQC - China Quality Certification	Yes / GB 12350 Safety Requirements for small Power Motors

6 Reliability**6.1 General**

Life expectancy L10 at TU = 40 °C	70.000 h	
Life expectancy L10 at TU max.	40.000 h	
Life expectancy L10 acc. to IPC 9591 at TU = 40 °C	117.500 h	

Copyright of this document, and design, is owned and the use or reproduction of the contents thereof, for purposes other than those specified, is prohibited. All rights are reserved in the event of the patent or the registration of a utility model or design.

Copyright reserved for the use of this document for other than the purposes specified. All rights are reserved in the event of the patent or the registration of a utility model or design.

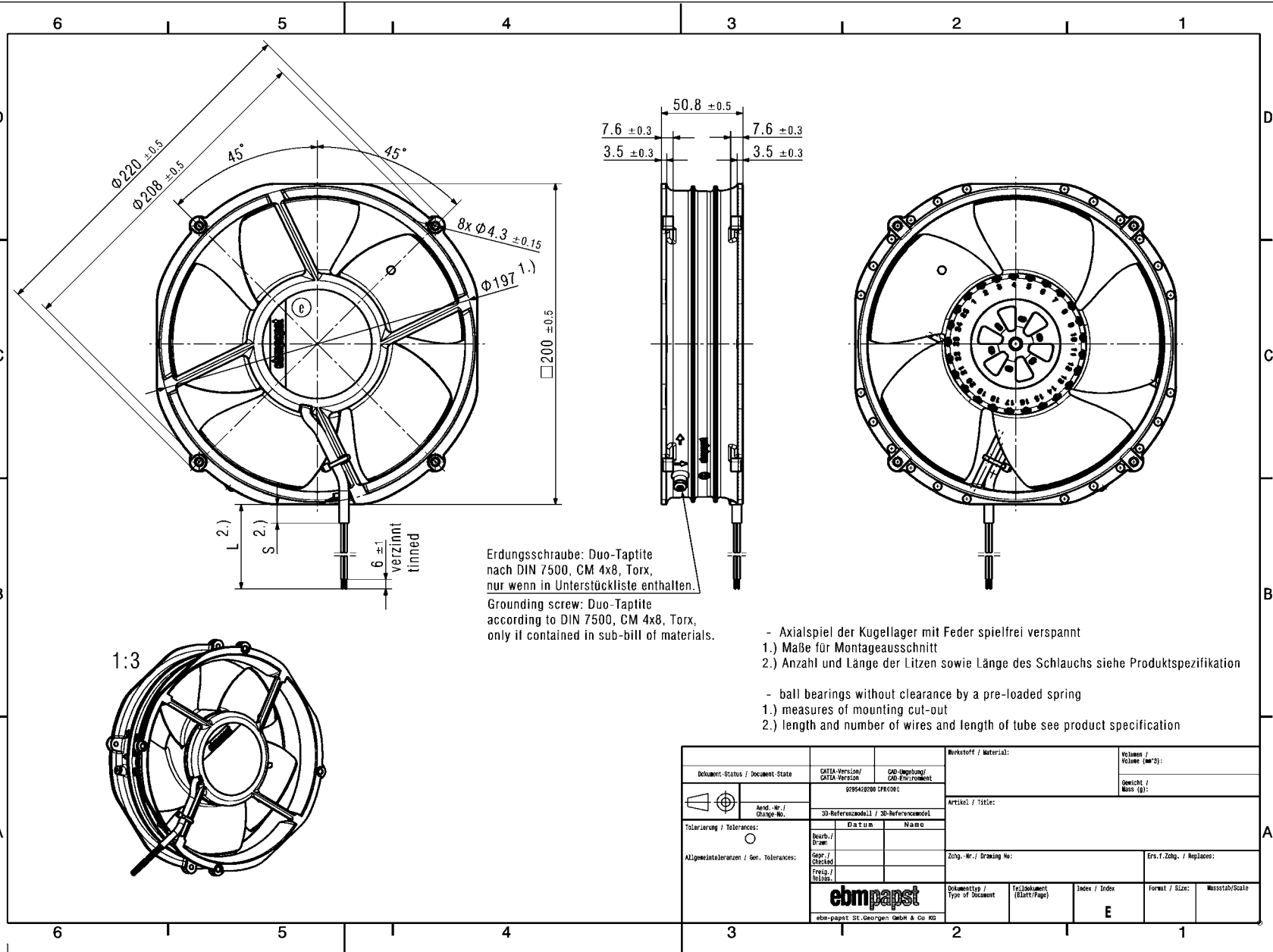

Erdungsschraube: Duo-Taptite nach DIN 7500, CM 4x8, Torx, nur wenn in Unterstückliste enthalten.
 Grounding screw: Duo-Taptite according to DIN 7500, CM 4x8, Torx, only if contained in sub-bill of materials.

- Axialspiel der Kugellager mit Feder spielfrei verspannt
- 1.) Maße für Montageausschnitt
- 2.) Anzahl und Länge der Litzen sowie Länge des Schlauchs siehe Produktspezifikation
- ball bearings without clearance by a pre-loaded spring
- 1.) measures of mounting cut-out
- 2.) length and number of wires and length of tube see product specification

Document-Status / Document-Status	CATIA-Version / CATIA-Version	CAD-Umgebung / CAD-Environment	Werkstoff / Material:	Volumen / Volume (cm ³):
				Gewicht / Mass (g):
	9295420200 CDR000		Artikel / Title:	
	3D-Referenzmodell / 3D-Reference Model		Zug.-Nr. / Drawing No:	Ers.f.-Zug. / Replaces:
Tolerierung / Tolerances:	Datum	Name		
Allgemeintoleranzen / Gen. Tolerances:	Bearb. / Drawn			
	Gepr. / Checked			
	Freig. / Released			
ebmpapst			Dokumenttyp / Type of Document	Index / Index
ebm-papst St. Georgen GmbH & Co KG			Format / Size:	Masstab/Scale
			E	