



## SPECIFICATION FOR APPROVAL

Customer STD

Description DC FAN

Part No. \_\_\_\_\_ REV. \_\_\_\_\_

Delta Model No. PFC0812DE-SP04 REV. 00

Sample Issue No. \_\_\_\_\_

Sample Issue Date APR.16.2008

PLEASE SEND ONE COPY OF THIS SPECIFICATION  
BACK AFTER YOU SIGNED APPROVAL FOR  
PRODUCTION PRE-ARRANGMENT.

APPROVED BY: \_\_\_\_\_

DATE : \_\_\_\_\_

DELTA ELECTRONICS, INC.  
TAOYUAN PLANT  
252, SHANG YING ROAD, KUEI SAN INDUSTRIAL ZONE  
TAOYUAN SHIEN, TAIWAN, R.O.C.  
TEL:886-(0)3-3591968  
FAX:886-(0)3-3591991

DELTA ELECTRONICS, INC.  
 252, SHANG YING ROAD, KUEI SAN  
 TAOYUAN HSIEN 333, TAIWAN, R. O. C.

TEL : 886-(0)3-3591968  
 FAX : 886-(0)3-3591991

SPECIFICATION FOR APPROVAL  
 \*\*\*\*\*

Customer: STD  
 -----  
 Description: DC FAN  
 -----  
 Customer P/N: REV:  
 -----  
 Delta Model NO.: PFC0812DE-SP04  
 -----  
 Sample Rev: 00 Issue NO:  
 -----  
 Sample Issue Date: APR.16.2008 Quantity:  
 -----

1. SCOPE:

THIS SPECIFICATION DEFINES THE ELECTRICAL AND MECHANICAL CHARACTERISTICS OF THE DC BRUSHLESS AXIAL FLOW FAN. THE FAN MOTOR IS WITH 3 PHASES, CORE POLES ARE 6, MAGNET POLES ARE 4 AND RECTIFYING METHOD IS WITH SENSOR.

2. CHARACTERS:

ITEM	DESCRIPTION
RATED VOLTAGE	12 VDC
OPERATION VOLTAGE	10.8 - 13.2 VDC
INPUT CURRENT	2.75 ( 3.30 MAX.) A
INPUT POWER	33.00 ( 39.60 MAX. ) W
SPEED	9000 R.P.M. ±10%
MAX. AIR FLOW (AT ZERO STATIC PRESSURE)	3.754 ( MIN. 3.379) M <sup>3</sup> /MIN 132.6 ( MIN. 119.3) CFM
MAX.AIR PRESSURE (AT ZERO AIR FLOW)	51.57 ( MIN. 41.77 ) mmH <sub>2</sub> O 2.030 ( MIN. 1.644) inchH <sub>2</sub> O
ACOUSTICAL NOISE (AVG.)	65.0 (MAX 70.0) dB-A
INSULATION TYPE	UL: CLASS A

(continued)

PART NO:

DELTA MODEL: PFC0812DE-SP04

INSULATION STRENGTH	10 MEG OHM MIN. AT 500 VDC (BETWEEN FRAME AND (+) TERMINAL)
DIELECTRIC STRENGTH	5 mA MAX. AT 500 VAC 60 Hz ONE MINUTE, (BETWEEN FRAME AND (+) TERMINAL)
EXTERNAL COVER	OPEN TYPE
LIFE EXPECTANCE	50,000 HOURS CONTINUOUS OPERATION AT 40 °C WITH 15 ~ 65 %RH.
ROTATION	CLOCKWISE VIEW FROM NAME PLATE SIDE
OVER CURRENT SHUT DOWN	THE CURRENT WILL SHUT DOWN, WHEN LOCKING ROTOR.
LEAD WIRE	UL 1061 -F- AWG #24 BLACK WIRE NEGATIVE(-) RED WIRE POSITIVE(+) BLUE WIRE (PWM) YELLOW WIRE (FOO)

- NOTES: 1. ALL READINGS ARE MEASURED AFTER STABLY WARMING UP THROUGH 10 MINUTES  
2. THE VALUES WRITTEN IN PARENS , ( ), ARE LIMITED SPEC.  
3. ACOUSTICAL NOISE MEASURING CONDITION:

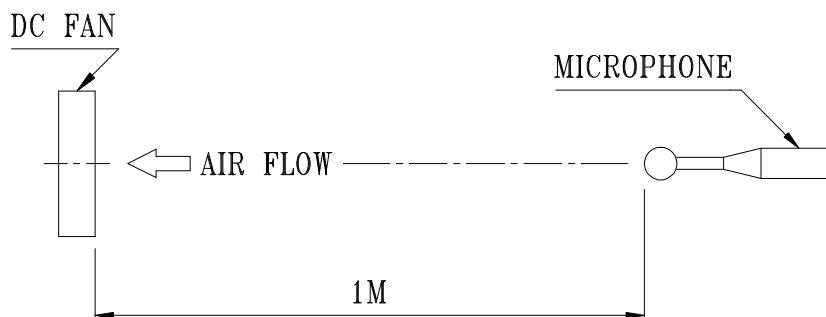

NOISE IS MEASURED AT RATED VOLTAGE IN FREE AIR IN ANECHOIC CHAMBER WITH B & K SOUND LEVEL METER WITH MICROPHONE AT A DISTANCE OF ONE METER FROM THE FAN INTAKE.

-----  
PART NO:  
-----

DELTA MODEL: PFC0812DE-SP04  
-----

3. MECHANICAL:

- 3-1. DIMENSIONS ----- SEE DIMENSIONS DRAWING
- 3-2. FRAME ----- PLASTIC UL: 94V-0
- 3-3. IMPELLER ----- PLASTIC UL: 94V-0
- 3-4. BEARING SYSTEM ----- TWO BALL BEARINGS
- 3-5. WEIGHT ----- 205 GRAMS

4. ENVIRONMENTAL:

- 4-1. OPERATING TEMPERATURE ----- -10 TO +60 DEGREE C
- 4-2. STORAGE TEMPERATURE ----- -40 TO +70 DEGREE C
- 4-3. OPERATING HUMIDITY ----- 5 TO 90 % RH
- 4-4. STORAGE HUMIDITY ----- 5 TO 95 % RH

5. PROTECTION:

5-1. LOCKED ROTOR PROTECTION

IMPEDANCE OF MOTOR WINDING PROTECTS MOTOR FROM FIRE IN 96 HOURS OF LOCKED ROTOR CONDITION AT THE RATED VOLTAGE.

5-2. POLARITY PROTECTION

BE CAPABLE OF WITHSTANDING IF REVERSE CONNECTION FOR POSITIVE AND NEGATIVE LEADS.

6. RE OZONE DEPLETING SUBSTANCES:

- 6-1. NO CONTAINING PBBs, PBB0s, CFCs, PBBEs, PBDPEs AND HCFCs.

7. PRODUCTION LOCATION

- 7-1. PRODUCTS WILL BE PRODUCED IN CHINA OR THAILAND OR TAIWAN.

PART NO:

DELTA MODEL: PFC0812DE-SP04

8. P & Q CURVE:

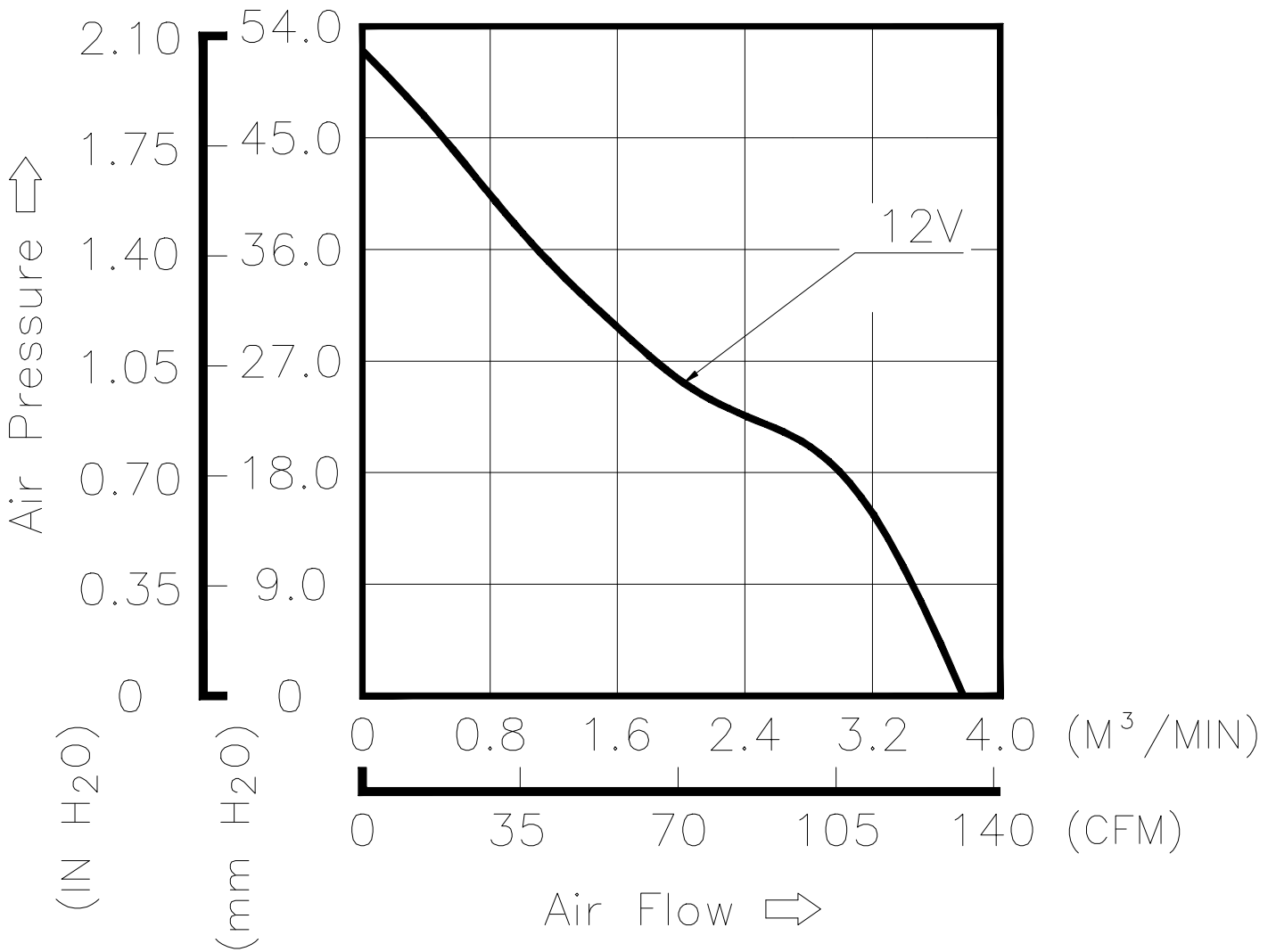

\* TEST CONDITION: INPUT VOLTAGE ----- OPERATION VOLTAGE  
TEMPERATURE ----- ROOM TEMPERATURE  
HUMIDITY ----- 65%RH

-----  
PART NO:  
-----

DELTA MODEL: PFC0812DE-SP04  
-----

### 9. DIMENSIONS DRAWING

LABEL:

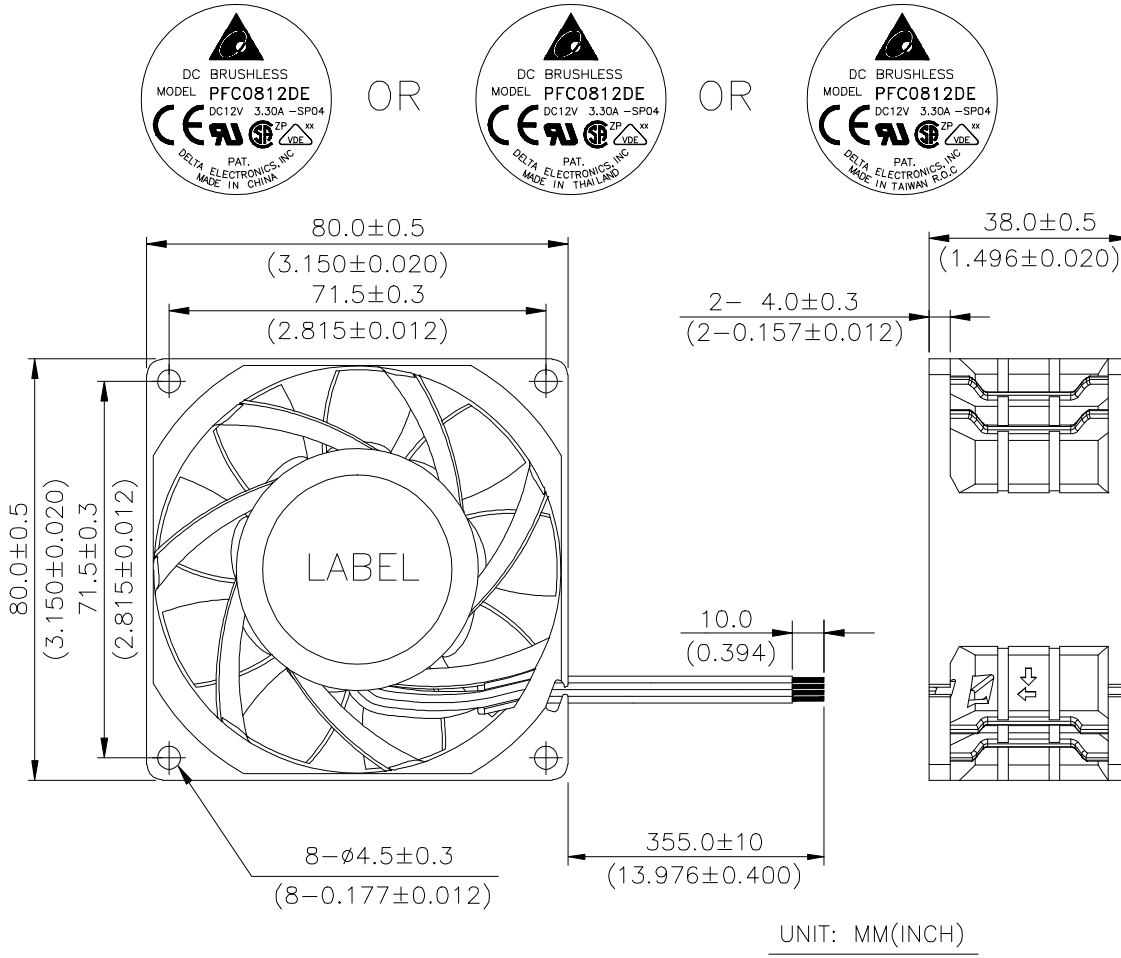

NOTES:

- LEAD WIRE UL 1061 -F- AWG #24 (MUST BE APPROVED BY DELTA)  
RED WIRE -----(+)  
BLACK WIRE -----(-)  
BLUE WIRE ----- (PWM)  
YELLOW WIRE -----(FOO)
- THIS PRODUCT IS RoHS COMPLIANT

-----  
PART NO:  
-----

DELTA MODEL: PFC0812DE-SP04  
-----

10. FREQUENCY GENERATOR (FG) SIGNAL:

1. OUTPUT CIRCUIT - OPEN COLLECTOR MODE:

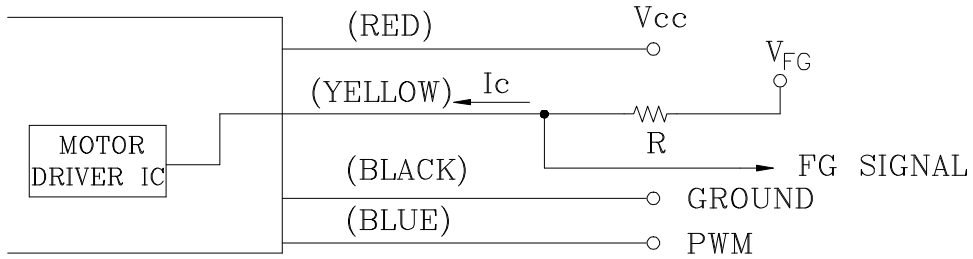

CAUTION: THE FG SIGNAL LEAD WIRE MUST BE KEPT AWAY FROM  
" + " LEAD WIRE & " - " LEAD WIRE.

2. SPECIFICATION:

$$V_{CE(sat)} = 0.5V \text{ MAX}$$

$$V_{FG} = 13.2V \text{ MAX}$$

$$I_c = 5mA \text{ MAX.}$$

$$R \geq V_{FG} / I_c$$

3. FREQUENCY GENERATOR WAVEFORM:



FAN RUNNING FOR 4 POLES

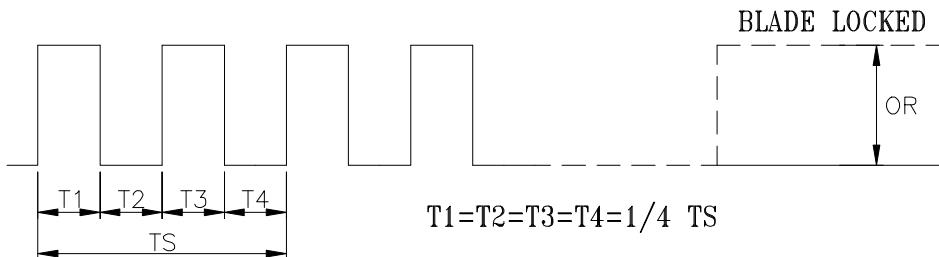

N=R.P.M

$$TS = 60 / N (\text{SEC})$$

\*VOLTAGE LEVEL AFTER BLADE LOCKED

\*4 POLES

-----  
PART NO:  
-----

DELTA MODEL: PFC0812DE-SP04  
-----

11. PWM CONTROL SIGNAL:

SIGNAL VOLTAGE RANGE: 0~15VDC

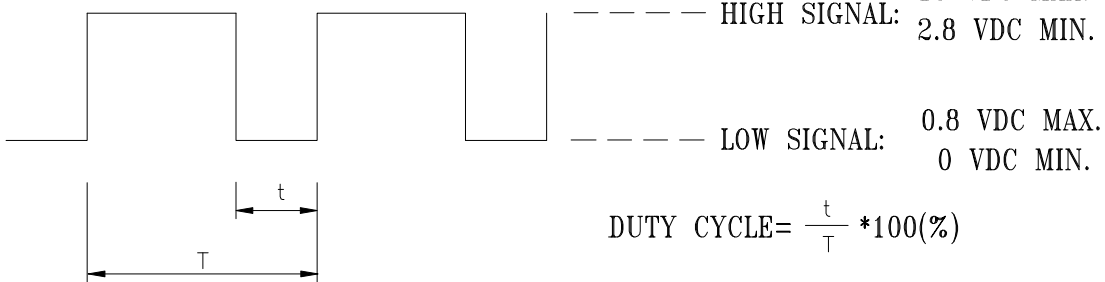

- THE FREQUENCY FOR CONTROL SIGNAL OF THE FAN SHALL BE ABLE TO ACCEPT A 30HZ~300KHZ.
- THE PREFERRED OPERATING POINT FOR THE FAN IS 20KHZ.
- AT 100% DUTY CYCLE,THE ROTOR WILL SPIN AT MAXIMUM SPEED.
- AT 0% DUTY CYCLE,THE ROTOR WILL STOP.
- WITH CONTROL SIGNAL LEAD DISCONNECTED,THE FAN WILL SPIN AT MAXIMUM SPEED.

12. SPEED VS PWM CONTROL SIGNAL: (AT RATED VOLTAGE & PWM FREQUENCY=20KHZ)

DUTY CYCLE (%)	SPEED R.P.M. (REF.)	CURRENT (A) TYP.
100	9000±10%	2.75
75	6750±10%	1.15
50	4500±10%	0.50
25	2250±10%	0.08
0	0	0.02

13. PWM CONTROL LEAD WIRE INPUT IMPEDANCE:

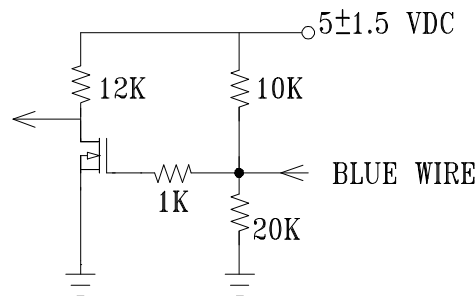

- 13-1. THE FAN SPEED WILL DEFAULT TO MAXIMUM WHEN THE SPEED CONTROL INPUT IS LEFT UNCONNECTED OR CONNECTED TO THE GROUND.





## **Descriptions:**

- 1. Delta will not guarantee the performance of the products if the application condition falls outside the parameters set forth in the specification.**
- 2. A written request should be submitted to Delta prior to approval if deviation from this specification is required.**
- 3. Please exercise caution when handling fans. Damage may be caused when pressure is applied to the impeller, if the fans are handled by the lead wires, or if the fans are hard-dropped to the production floor.**
- 4. Except as pertains to some special designs, there is no guarantee that the products will be free from any such safety problems or failures as caused by the introduction of powder, droplets of water or encroachment of insect into the hub.**
- 5. The above-mentioned conditions are representative of some unique examples and viewed as the first point of reference prior to all other information.**
- 6. It is very important to establish the correct polarity before connecting the fan to the power source. Positive (+) and Negative (-). Damage may be caused to the fans if connection is with reverse polarity, as there is no foolproof method to protect against such error.**
- 7. Delta fans are not suitable where any corrosive fluids are introduced to their environment.**
- 8. Please ensure all fans are stored according to the storage temperature limits specified. Do not store fans in a high humidity environment. We highly recommend performance testing is conducted before shipping, if the fans have been stored over 6 months.**
- 9. Not all fans are provided with the Lock Rotor Protection feature. If you impair the rotation of the impeller for the fans that do not have this function, the performance of those fans will lead to failure.**
- 10. Please be cautious when mounting the fan. Incorrect mounting of fans may cause excess resonance, vibration and subsequent noise.**
- 11. It is important to consider safety when testing the fans. A suitable fan guard should be fitted to the fan to guard against any potential for personal injury.**
- 12. Except where specifically stated, all tests are carried out at relative (ambient) temperature and humidity conditions of 25°C, 65%. The test value is only for fan performance itself.**
- 13. Be certain to connect an “over 4.7µF” capacitor to the fan externally when the application calls for using multiple fans in parallel, to avoid any unstable power.**